



SIDDARTHA EDUCATIONAL ACADEMY GROUP OF INSTITUTIONS
(Approved by AICTE, New Delhi & Affiliated to JNTUA, Ananthapuramu)

An ISO 9001:2015 & ISO 14001: 2015 Certified Institution

Near C.Gollapalli, Tirupati- 517505, Andhra Pradesh

3.2.2. Number of Workshops/ Seminars/ Conferences including on Research Methodology, Intellectual Property Rights and Entrepreneurship conducted during the Ac. Yr. 2018-2019

S.No	Name of the program	Name of the convener	Details of the Resource Person	Date from – to	No. of Participant
1.	HVDC Technology	Mr. M.V. Ramanaiya	Mr. Tejeshwar Rao Senior Trainer, Datapoint	28.12.2019	45
2.	A Two Day Workshop On Soft Skills & Development	Mr. M. Muninjayudu	Dr. MAHESH PAVAN Soft skills Trainer, Bangalore	11.03.2019 & 12.03.2019	84
3.	Advances in Communication systems	Mr. T. Venkata Ramana	Ms. G. Mamatha Assco. Prof, ECE, JNTUA, Anathapur	30.01.2019 & 31.01.2019	95
4.	Emerging Trends in IT Industries	Mr. N. Anand Reddy	Mr. Venkataraman CADD Centre, Tirupati	29.01.2019	32
5.	Applications of Nano Materials	Dr. P. Ravi	Ms. V. Bebi SEAGI, Asst. Prof. Chemistry	21.01.2019	43
6.	Structural and Foundation Analysis	Mr. S. Vinodh Kumar	Ms. S. Mounika Structural Engineering, Quest Global	27.10.2018	80
7.	A seminar on Business Ethics	Mrs. K.Hima Bindu	Dr. S. MAHESH Program Manager, WPP Advertising company	07.09.2018	80
8.	Advanced manufacturing Processes	Mr. D. Dinesh	Prof. J. Uday prakesh Professor, VelTech, Chennai	21.08.2018	90
9.	Role of mathematics in Engineering	Mr. K.M. Basha	Dr. P. Ravi HoD/BS&H	20.08.2018	50
10.	Introduction to Python	Mr. N. Anand Reddy	C. Ramesh Reddy SREC, Tirupati	19.07.2018 & 20.07.2018	30
11.	Adaptive Signal Processing	Mr. K. Bhaskar	Dr. C. Subhas Professor, Dept of ECE, SVNE	23.07.2018	70

Principal
Siddhartha Educational Academy
Group of Institutions
Near C.GOLLAPALLI, Tirupati (R)-517 505
Tirupati Dist. (A.P.)



SIDDARTHA EDUCATIONAL ACADEMY GROUP OF INSTITUTIONS

(An Integrated Campus for Engineering & MBA)

Approved by the AICTE, New Delhi & Affiliated to JNTUA, Anantapur
Near C. Gollapalli, TIRUPATI - 517 505 Andhra Pradesh

EEE/PERMISSION/WORKSHOP/2019

Permission letter

Date: 16/12/2019

From

Mr. D. Bala Subramanyam,

HOD, Dept of EEE,

SEAGI, Tirupati.

To

The Principal,

SEAGI,

Tirupati.

Respected Sir,

Sub: Requesting permission for conducting one day workshop – Reg.

We are planning to conduct one day workshop on “HVDC THCHNOLOGY” for our 3rd and 4th year students to enhance their knowledge in recent trends. I request you to grant permission to conduct the workshop on 28-12-2019.

Thanking you Sir,

Yours sincerely,

(D Bala Subramanyam)

HOD
Dept. of EEE
Siddhartha Educational Academy
Group of Institutions
TIRUPATI-517 505

PRINCIPAL
Siddhartha Educational Academy
Group of Institutions
Near C.GOLLAPALLI, Tirupati (R)-517 505
Tirupati Dist. (A.P.)



SIDDARTHA EDUCATIONAL ACADEMY GROUP OF INSTITUTIONS

(An Integrated Campus for Engineering & MBA)

Approved by the AICTE, New Delhi & Affiliated to JNTUA, Anantapur
Near C. Gollapalli, TIRUPATI - 517 505 Andhra Pradesh

Date: 18.12.2019

Circular

All the staff and students are hereby informed that Electrical and Electronics Engineering Department is organizing a one-day workshop on "HVDC THCHNOLOGY" by Mr .Tejeshwar Rao, Datapoint, Hyderabad, on 28.12.19. All the EEE students of 3rd and 4th year are instructed to attend the program without fail.

Venue: E-Class Room

Timings: 10 AM onwards

HOD / EEE

HOD
Dept. of EEE
Siddhartha Educational Academy
Group of Institutions
TIRUPATI-517 505



Principal

PRINCIPAL
Siddhartha Educational Academy
Group of Institutions
Near C.GOLLAPALLI, Tirupati (R)-517 505
Tirupati Dist. (A.P.)

Copy to

1. Data point, Hyderabad.
2. The Principal, SEAGI Tirupati.
3. Department file.
4. Notice board.

SIDDARTHA EDUCATIONAL ACADEMY GROUP OF INSTITUTIONS



(An Integrated Campus for Engineering & MBA)
Approved by the AICTE, New Delhi & Affiliated to JNTUA, Anantapur
Near C. Gollapalli, TIRUPATI - 517 505 Andhra Pradesh

BANNER OF WORKSHOP ON "HVDC TECHNOLOGY"

One Day Workshop on
HVDC Technology



28th December 2019 **Venue: E-Class Room**

Organized by
DEPARTMENT OF ELECTRICAL AND ELECTRONICS ENGINEERING
SIDDHARTHA ACADEMY GROUP OF INSTITUTIONS
AN Integrated Campus for Engineering and MBA
Approved by AICTE, New Delhi & Affiliated to JNTUA, Ananthapuramu

PRINCIPAL
Siddhartha Educational Academy
Group of Institutions
Near C.GOLLAPALLI, Tirupati (R)-517 505
Tirupati Dist. (A.P.)



SIDDARTHA EDUCATIONAL ACADEMY GROUP OF INSTITUTIONS

(An Integrated Campus for Engineering & MBA)

Approved by the AICTE, New Delhi & Affiliated to JNTUA, Anantapur
Near C. Gollapalli, TIRUPATI - 517 505 Andhra Pradesh

WORKSHOP ON "HVDC TECHNOLOGY"

PHOTOS OF ONE DAY WORKSHOP ON HVDC TECHNOLOGY:

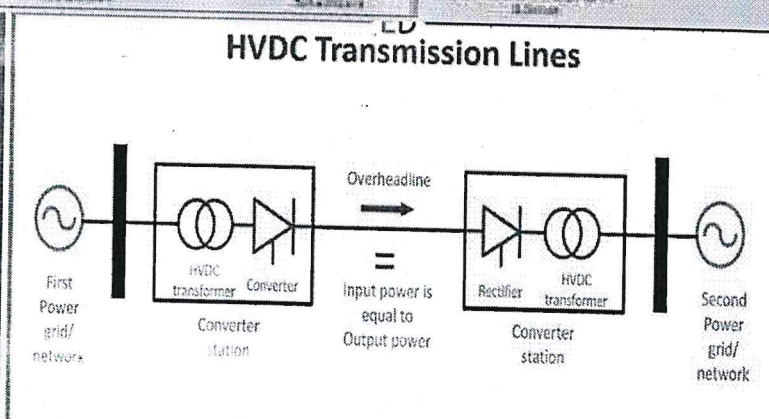
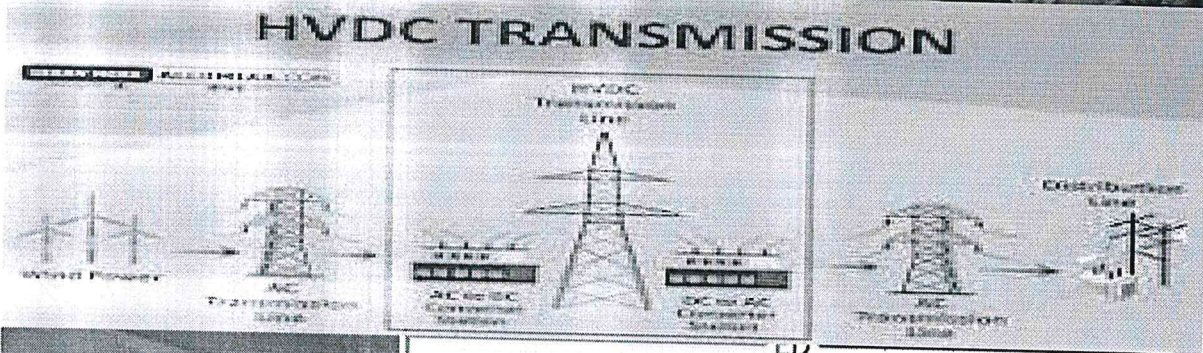

The High Voltage Direct Current (HVDC) transmission system uses direct current for the transmission of power over long distances. The HVDC transmission system provides efficient and economic transmission of power even to very long distances that meet the requirements of growing load demands. Due to its simple constructional feature and less complexity, research and development authority discovered its usage in modern power transmission.

PRINCIPAL
Siddhartha Educational Academy
Group of Institutions
Near C. Gollapalli, TIRUPATI



SIDDARTHA EDUCATIONAL ACADEMY GROUP OF INSTITUTIONS

(An Integrated Campus for Engineering & MBA)

Approved by the AICTE, New Delhi & Affiliated to JNTUA, Anantapur
Near C. Gollapalli, TIRUPATI - 517 505 Andhra Pradesh

WORKSHOP ON "HVDC TECHNOLOGY"

Attendance Sheet

S. No.	Roll No	Student Name	28-12-2019
1	169L1A0201	BUGGA LOKESH	P
2	169L1A0202	CHINNAOBULAI AHGARI SRAVANTHI	P
3	169L1A0203	GUTALA VENKATESH REDDY	P
4	169L1A0204	MEKALA SIREESHA	(A)
5	169L1A0205	NALLAPOTHULA SIVA KUMAR	P
6	169L1A0206	PASALA SANJEEV	P
7	169L1A0207	PYAYALA RAMYA	P
8	169L1A0208	S M TEJASWI	P
9	179L5A0201	BIRRU VARUN KUMAR	P
10	179L5A0202	JANGAM REDDY CHANDRASEKHARA REDDY	P
11	179L5A0203	JOTHA GANESH	P
12	179L5A0204	JOTHA MAHESH	P
13	179L5A0205	MANAVARTHI KULADEEP	P
14	179L5A0206	MANCHA BALAJI	P
15	179L5A0207	NAMPALLI DINESH	(A)
16	179L5A0208	VELPUCHERLA SIDDESWARI	P
17	179L1A0201	A K PRAVEEN KUMAR	P
18	179L1A0202	B C CHANDRA SEKHAR BABU	P
19	179L1A0204	GENTEM BALAKRISHNA	P
20	179L1A0206	KOLA RAGHU	P
21	179L1A0207	KUNCHAPU VENKATASAI	P
22	179L1A0208	LAKKIREDDY KIRAN KUMAR REDDY	P
23	179L1A0209	MANUBOLU SURESH	P
24	179L1A0210	PEDIVEETI VAMSIDHAR	P
25	179L1A0211	PENAGALURU LAVANYA	P
26	179L1A0212	POTHULA GOVARDHAN	(A)
27	179L1A0213	PUCHAKATLA BALAJI	P
28	179L1A0214	PULI BABITHA	P
29	179L1A0216	SURYA V	(A)
30	179L1A0217	VADDIPURI ANITHA	P
31	179L1A0218	WESLEY PRINCY MARGARET	P
32	189L5A0201	BHARATH KUMAR S	P
33	189L5A0202	CHINTALA SWAPNA	P
34	189L5A0203	GAVVAJI SHANMUKHA KRISHNA YADAV	P
35	189L5A0204	IKUTTI PAVAN	P

SIDDARTHA EDUCATIONAL ACADEMY GROUP OF INSTITUTIONS

(An Integrated Campus for Engineering & MBA)

Approved by the AICTE, New Delhi & Affiliated to JNTUA, Anantapur
Near C. Gollapalli, TIRUPATI - 517 505 Andhra Pradesh



36	189L5A0205	MALLAM HEMANTH	P
37	189L5A0206	MALLELA BALAJI	P
38	189L5A0207	PANDURU NIKHIL KUMAR	P
39	189L5A0208	RAJUPALEM SIVA SAI LAKSHMI	P
40	189L5A0209	RAMIREDDY VAMSIDHAR REDDY	P
41	189L5A0210	SUDA UPENDRA REDDY	P
42	189L5A0211	VENNAPUSA RUCHITHA	P
43	189L5A0212	YANGALAREDDYGARI RAJA SEKHAR REDDY	P
44	189L5A0213	YEDDALA VINAY	P
45	189L5A0214	YELLAMAKURU SIVA PRASAD REDDY	P
Signature of the faculty			

HOD / EEE

(D Bala Subramanyam)

HOD
Dept. of EEE
Siddhartha Educational Academy
Group of Institutions
TIRUPATI-517 505

PRINCIPAL
Siddhartha Educational Academy
Group of Institutions
Near C.GOLLAPALLI, Tirupati (R)-517 505
Tirupati Dist. (A.P.)



SIDDARTHA EDUCATIONAL ACADEMY GROUP OF INSTITUTIONS

(An Integrated Campus for Engineering & MBA)

Approved by the AICTE, New Delhi & Affiliated to JNTUA, Anantapur
Near C. Gollapalli, TIRUPATI - 517 505 Andhra Pradesh

Electrical and Electronics Engineering Department

Summary Report of one Day workshop

The one day workshop on “HVDC TECHNOLOGY” was organized by Electrical and Electronics Engineering Department in association with data point Hyderabad as a part of the department Activities .The event was scheduled on 28th December 2019. A total of 45 participants comprising Principal, Head of the Department, faculty members and students attended the program.

The program started at 10:00AM with prayer song by Ms. Mekala Sireesha and team from III EEE. This was followed by a welcome address by Mr N.V Ramanaiya Assistant Professor, Department of EEE and Mr. D Bala Subramanyam, Head, Department of EEE introduced the resource person.

The first session is handed over to the Guest Speaker Mr .Tejeshwar Rao, Sr. Trainer, Data Point

, Hyderabad. He explained about HVDC technology, transmitting electricity over long distances with lower losses.

The next session is on interconnecting asynchronous grids. He explained about how HVDC technology is used for several purposes. The session ended at 3:50 PM.

The session ended with the Vote of thanks by Ms.E. Rekha, Assistant Professor, and Department of EEE.

Finally the workshop program concluded with the National Anthem.

HOD / EEE

HOD
Dept. of EEE
Siddhartha Educational Academy
Group of Institutions
TIRUPATI-517 505

PRINCIPAL
Siddhartha Educational Academy
Group of Institutions
Near C.GOLLAPALLI, Tirupati (R)-517 505
Tirupati Dist. (A.P.)



SIDDARTHA EDUCATIONAL ACADEMY GROUP OF INSTITUTIONS
(An Integrated Campus for Engineering & MBA)
Approved by AICTE, New Delhi & Affiliated to JNTUA, Ananthapuramu, AP.
Near C. Gollapalli, Tirupati – 517 505, Andhra Pradesh

MBA/CIR /SEMINAR/2018

Date: 04-09-2018

Circular

This is to inform the students of MBA that a seminar is intended to be organised on the topic **“Business Ethics”** which is scheduled on **07-09-2018**.

Therefore, the students are encouraged to attend the program without fail on the stipulated date.

HOD
Dept. of MBA
Siddhartha Educational Academy
Department of MBA
Group of Institutions
TIRUPATI - 517 505

Copy to:

1. The Faculty members
2. The Notice Board
3. The File

PRINCIPAL
Siddhartha Educational Academy
Group of Institutions
Near C.Gollapalli, Tirupati-517 505



SIDDARTHA EDUCATIONAL ACADEMY GROUP OF INSTITUTIONS
(An Integrated Campus for Engineering & MBA)
Approved by AICTE, New Delhi & Affiliated to JNTUA, Ananthapuramu, AP.
Near C. Gollapalli, Tirupati – 517 505, Andhra Pradesh

Department of MBA

A Seminar on “Business Ethics” on **07-09-2018**

Attendance Sheet

S.No	Register No	Name of the Student	Year	
1	179L1E0001	ALLURI GANGA RAJU	MBA II Year	P
2	179L1E0002	AMMIREDDY RAMIREDDY	MBA II Year	P
3	179L1E0003	ARIKOTAM JEEVAN KUMAR	MBA II Year	P
4	179L1E0004	AVULA NAGA MALLA REDDY	MBA II Year	P
5	179L1E0005	B SHAHRUKH SURYA	MBA II Year	P
6	179L1E0006	B VENKATESH NAIK	MBA II Year	P
7	179L1E0007	BAPANAPALLE LALITHA	MBA II Year	P
8	179L1E0008	BATHINI SIVAPRASAD	MBA II Year	P
9	179L1E0009	B VENKATA SURYA PRAKASH REDDY	MBA II Year	P
10	179L1E0010	BHEEMA VENKATESH	MBA II Year	P
11	179L1E0011	BHUMIREDDY SRIKANTH REDDY	MBA II Year	P
12	179L1E0012	BODIREDDI UDAY	MBA II Year	A
13	179L1E0013	BOGIREDDY MOUNIKA	MBA II Year	P
14	179L1E0014	B PAVAN KUMAR REDDY	MBA II Year	P
15	179L1E0015	BOPANA NAGA KALYANI	MBA II Year	P
16	179L1E0016	CHAITHANYA JADABALLI	MBA II Year	P
17	179L1E0017	CHALLA VIGNESH	MBA II Year	P
18	179L1E0018	CHINNADASARI HARIKA	MBA II Year	P
19	179L1E0019	CHITHRALA VIJAYAKUMAR	MBA II Year	P
20	179L1E0020	CHOWDAPPA GARI NAGARJUNA	MBA II Year	A
21	179L1E0021	D PRAVEEN	MBA II Year	P
22	179L1E0022	D ARUN KUMAR REDDY	MBA II Year	P
23	179L1E0023	DIGUVA SODAM BHAGAWAN REDDY	MBA II Year	P
24	179L1E0024	DUNNAPOTHALA SRIKANTH	MBA II Year	P
25	179L1E0025	EEGA SRINATH REDDY	MBA II Year	P
26	179L1E0026	G RAVIKUMAR	MBA II Year	P
27	179L1E0027	G YESWANTH	MBA II Year	P
28	179L1E0028	GANTAPEDDA PRUDVI RAJ	MBA II Year	P
29	179L1E0029	GUGGILLA HAREENDRA	MBA II Year	P
30	179L1E0030	GUGGILLA RAMA MOHAN	MBA II Year	P
31	179L1E0031	GULURI SAIKRISHNA	MBA II Year	P
32	179L1E0032	GUNTIKOVILA MIDHILESH	MBA II Year	P
33	179L1E0033	JADA DINA SURYA	MBA II Year	P
34	179L1E0034	JADA MADHU	MBA II Year	P

35	179L1E0035	JARUGUMALLA REDDI PRAVEEN	MBA II Year	P
36	179L1E0036	JAVVAJI VENKATA RAMA NAVEEN	MBA II Year	P
37	179L1E0037	JEEDI PRASAD	MBA II Year	P
38	179L1E0038	K DINESH REDDY	MBA II Year	P
39	179L1E0039	K SUJITHA	MBA II Year	P
40	179L1E0040	K SWATHI	MBA II Year	P
41	179L1E0041	KADIRI NARMADA	MBA II Year	P
42	179L1E0042	KAMMAIAHGARI MALLIKARJUNA	MBA II Year	P
43	179L1E0043	KANDIKONDA RADHA	MBA II Year	P
44	179L1E0044	KASIREDDY VEERANAGIREDDY	MBA II Year	P
45	179L1E0045	KASULA PRASANTH	MBA II Year	P
46	179L1E0046	KATAMREDDY YASASWINI	MBA II Year	P
47	179L1E0047	KATHI MANIKANTA	MBA II Year	P
48	179L1E0048	K GURUSANKAR SHIRIDINADH	MBA II Year	P
49	179L1E0049	KONDASANI RAMANJULU	MBA II Year	P
50	179L1E0050	KONDURI SREEKANTH NAIDU	MBA II Year	P
51	179L1E0051	KOTAGUNTA VENKATESWARLU	MBA II Year	P
52	179L1E0052	KRISHNAMOHAN NAIK	MBA II Year	P
53	179L1E0053	LOMADA JAGAN MOHAN REDDY	MBA II Year	P
54	179L1E0054	M VAMSIPRIYA	MBA II Year	A
55	179L1E0055	MALLAM RAJEE	MBA II Year	P
56	179L1E0056	MANCHURI SATHEESH	MBA II Year	P
57	179L1E0057	MANCHURU RUPA	MBA II Year	P
58	179L1E0058	NAGASAMUDRAM ASHOK KUMAR	MBA II Year	P
59	179L1E0059	NAKKA RUPASREE	MBA II Year	P
60	179L1E0060	NANDYALA DIVAKAR	MBA II Year	P
61	179L1E0061	NARAVARA SAI KUMAR	MBA II Year	P
62	179L1E0062	NARNAMANGALAM JYOTHI	MBA II Year	P
63	179L1E0063	ORUGANTI NARESH	MBA II Year	P
64	179L1E0064	P RAVIKUMAR	MBA II Year	P
65	179L1E0065	PALLEPU REDDY SEKAR	MBA II Year	P
66	179L1E0066	PALURU VASUDEVA REDDY	MBA II Year	P
67	179L1E0067	PAMULA HEMALATHA	MBA II Year	P
68	179L1E0068	P ACHYUTHANANDA REDDY	MBA II Year	P
69	179L1E0069	PASUPELETI MUNI CHANDRA	MBA II Year	P
70	179L1E0070	PENUGONDA LOKESH	MBA II Year	P
71	179L1E0071	POTHUGUNTA DIVYA	MBA II Year	P
72	179L1E0072	PUSALA ROOPA	MBA II Year	P
73	179L1E0073	R SNEHASEEL	MBA II Year	P
74	179L1E0074	RAIPATI RAVI	MBA II Year	P
75	179L1E0075	RAJPALEM HARIPRASAD	MBA II Year	P
76	179L1E0076	RAYA REDDI RADHA	MBA II Year	P
77	179L1E0077	ROWTHU DAMODARA	MBA II Year	P
78	179L1E0078	S SREENIVASA	MBA II Year	P
79	179L1E0079	SAYED SHAHEED	MBA II Year	P
80	179L1E0080	SHEIK TEEPU NAGEENA	MBA II Year	P
81	179L1E0081	T HARI KRISHNA	MBA II Year	P



SIDDARTHA EDUCATIONAL ACADEMY GROUP OF INSTITUTIONS
(An Integrated Campus for Engineering & MBA)
Approved by AICTE, New Delhi & Affiliated to JNTUA, Ananthapuramu, AP.
Near C. Gollapalli, Tirupati – 517 505, Andhra Pradesh

82	179L1E0082	TALARI REDDEIAH	MBA II Year	P
83	179L1E0084	THANNEERU SREENIVASULU	MBA II Year	P
84	179L1E0085	THOTA ESWARIAIAH	MBA II Year	P
85	179L1E0086	TUMMAGINJALA TIMMARAJU	MBA II Year	P
86	179L1E0087	TUMMAGINJALA VENKATARAMANA	MBA II Year	P
87	179L1E0088	VADDIREDDY REDDY RANI	MBA II Year	P
88	179L1E0089	VIJALAPURAM SURESHKUMAR	MBA II Year	P
89	179L1E0090	PARITALA PAVAN KALYAN	MBA II Year	P
90	179L1E0091	THUMMALA MANOJKUMAR REDDY *	MBA II Year	P
91	179L1E0092	SETTIPALLI PAVAN KUMAR REDDY	MBA II Year	A
92	179L1E0093	MITTAPALLI GURUPRASAD REDDY	MBA II Year	A
93	179L1E0094	SARASAPALLI A SHARIF	MBA II Year	A
94	179L1E0095	CHITRAJU DAMODHAR NAIDU	MBA II Year	P
95	179L1E0096	K MANIDEEP	MBA II Year	P

Co-ordinator

HOD
Dept. of MBA
Siddhartha Educational Academy
Group of Institutions
TIRUPATI - 517 505

PRINCIPAL
Siddhartha Educational Academy
Group of Institutions
Near C.Gollapalli, Tirupati-517 505



SIDDARTHA EDUCATIONAL ACADEMY GROUP OF INSTITUTIONS

(An Integrated Campus for Engineering & MBA)

Approved by AICTE, New Delhi & Affiliated to JNTUA, Ananthapuramu, AP.

Near C. Gollapalli, Tirupati – 517 505, Andhra Pradesh

Department of MBA

Summary Report on Seminar

A Seminar on “BUSINESS ETHICS” was conducted by department of MBA on 7th September 2018. A total of 80 comprising Head of MBA department, faculty members of MBA department attended the Seminar.

The Program started at 10:00am with prayer song by Mrs.K.Hima Bindu, Assistant Professor, Department of MBA, followed by welcome address by Mrs.M.B.Jyothi, Assistant Professor, Department of MBA to resource person and participants, Mr.P.Bayya Reddy, Head of MBA department introduced by resource person.



The session is handover to the guest speaker **Dr.S.Mahesh**, Program Manager, WPP Advertising company & he spoke on the “BUSINESS ETHICS”, Benefits of Business Ethics, Unethical Practises, Ethics for Managers etc..

The entire program was an interactive session and the speaker answered many queries raised by the participants,

The session ended with the vote of thanks proposed by Prof.P.Niranjan Reddy, Professor, Department of MBA.

The entire program was coordinated successfully with the support of the principal and faculty.

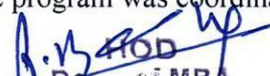
P. Bayya Reddy
Head of MBA
Siddhartha Educational Academy
Group of Institutions
Near C. Gollapalli, Tirupati-517 505

PRINCIPAL
Siddhartha Educational Academy
Group of Institutions
Near C.Gollapalli, Tirupati-517 505



SIDDARTHA EDUCATIONAL ACADEMY GROUP OF INSTITUTIONS (An Integrated Campus for Engineering & MBA) Approved by AICTE, New Delhi & Affiliated to JNTUA, Ananthapuramu, AP. Near C. Gollapalli, Tirupati – 517 505, Andhra Pradesh

From

P Sai Prasad
HOD, Dept of ECE
SEAGI, Tirupati.

To

The Principal,
SEAGI,
Tirupati.
Respected sir,

Sub: Requesting permission for conducting two day's workshop- reg.

We are planning to conduct two day's workshop on "Advances in Communication Systems" for students to enhance their knowledge in recent trends. I request you to grant permission to conduct workshop on 30-01-2019 & 31-01-2019.

Thanking you sir,

Yours sincerely,

(P Sai Prasad)

HOD

Dept. of ECE

Siddhartha Educational Academy
Group of Institutions
TIRUPATI - 517 505

Resource person

Mrs. G. Mamatha,
ASSOCIATE PROFESSOR, Dept of ECE.
JNTUA, Ananthapuramu, AP.



SIDDARTHA EDUCATIONAL ACADEMY GROUP OF INSTITUTIONS (An Integrated Campus for Engineering & MBA) Approved by AICTE, New Delhi & Affiliated to JNTUA, Ananthapuramu, AP. Near C. Gollapalli, Tirupati – 517 505, Andhra Pradesh

Circular

Date: 24.01.2019.

All the staff and students are hereby informed that Electronics and Communication engineering department is organized a two day workshop on “Advances in COMMUNICATION SYSTEMS” by Mrs. G. Mamatha, ASSOCIATE PROFESSOR, Dept of ECE. JNTUA, Ananthapuramu, AP. On 30-01-2019 & 31-01-2019. So, all the II and III year students are instructed to attend the program without fail.

Venue: ECE seminar Hall

Timings : 10 am onwards



HoD / ECE

Dept. of ECE

Siddhartha Educational Academy
Group of Institutions
TIRUPATI - 517 505



Principal

PRINCIPAL
Siddhartha Educational Academy
Group of Institutions
Near C.Gollapalli, Tirupati-517 505



SIDDARTHA EDUCATIONAL ACADEMY GROUP OF INSTITUTIONS (An Integrated Campus for Engineering & MBA) Approved by AICTE, New Delhi & Affiliated to JNTUA, Ananthapuramu, AP. Near C. Gollapalli, Tirupati – 517 505, Andhra Pradesh

WORKSHOP

ON

Advances in COMMUNICATION SYSTEMS

BY

Mrs. G. Mamatha,

ASSOCIATE PROFESSOR, Dept of ECE.

JNTUA, Ananthapuramu, AP.

Organized By

Department Of

ELECTRONICS AND COMMUNICATION ENGINEERING

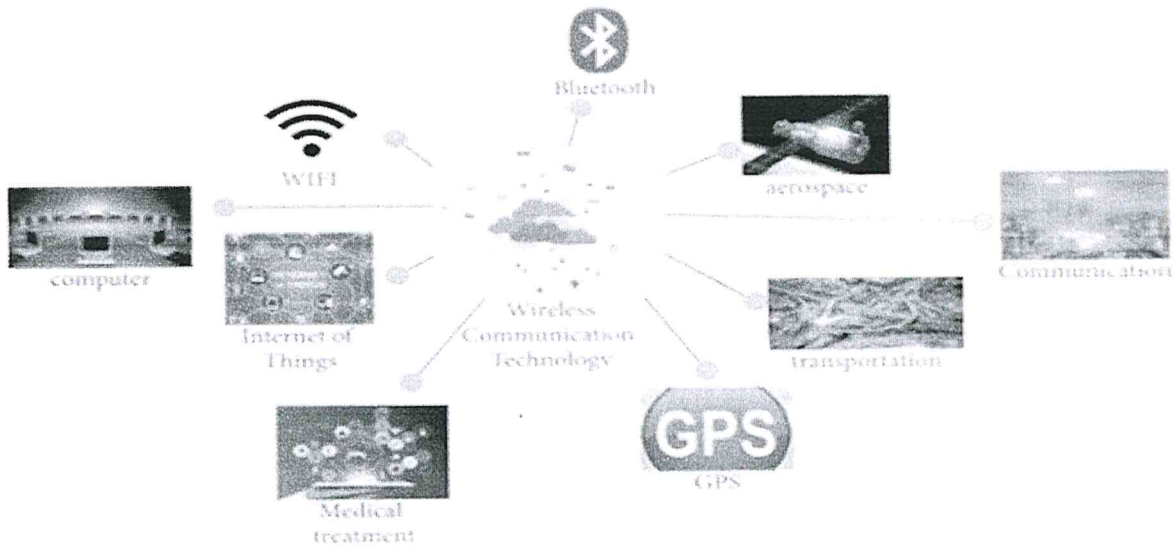

VENUE

SEAT E-Class Room

Date: 30-01-2019 & 31-01-2019

From 10.00 A.M To 04.00 P.M

Co-ordinator

T Venkata Ramana,

Assistant professor,

Dept of ECE, SEAT

P. Srinivas
HOD

**Dept. of ECE
Siddhartha Educational Academy
Group of Institutions
TIRUPATI - 517 505**

or

**PRINCIPAL
Siddhartha Educational Academy
Group of Institutions
Near C.Gollapalli, Tirupati-517 505**



SIDDARTHA EDUCATIONAL ACADEMY GROUP OF INSTITUTIONS (An Integrated Campus for Engineering & MBA) Approved by AICTE, New Delhi & Affiliated to JNTUA, Ananthapuramu, AP. Near C. Gollapalli, Tirupati – 517 505, Andhra Pradesh



Students attend the presentation



P. Ishy
HOD
Dept. of ECE
Siddhartha Educational Academy
Group of Institutions
TIRUPATI - 517 505

al
PRINCIPAL
Siddhartha Educational Academy
Group of Institutions
Near C.Gollapalli, Tirupati-517 505



SIDDARTHA EDUCATIONAL ACADEMY GROUP OF INSTITUTIONS (An Integrated Campus for Engineering & MBA) Approved by AICTE, New Delhi & Affiliated to JNTUA, Ananthapuramu, AP. Near C. Gollapalli, Tirupati – 517 505, Andhra Pradesh

ELECTRONICS AND COMMUNICATION ENGINEERING DEPARTMENT

Attendance

Sl. No.	Roll No.	Name of the Candidate	Remarks
1	189L1A0401	AKKARAPAKAM DIVYA	✓
2	189L1A0402	AKULA LINGAIAH	✓
3	189L1A0403	AMBU LIKHITHA	✓
4	189L1A0404	ANNAPU REDDY VARA PRASAD REDDY	✓
5	189L1A0405	ATOLLA CHINNA BHARADWAZ	✓
6	189L1A0406	BHEEMA VINITHA	✓
7	189L1A0407	BIJIVEMULA MEGHANA REDDY	✓
8	189L1A0408	BIJIVEMULA SUMANTHKUMAR REDDY	✓
9	189L1A0409	BUGGA JAGADEESH KUMAR	✓
10	189L1A0410	BUJJAMMAGARI GANGA LAKSHMI	✓
11	189L1A0411	BUSSA CHANDRAMOULI	✓
12	189L1A0412	CHALLA VINITHA	✓
13	189L1A0413	CHEEMALA SAISUSMITHA	✓
14	189L1A0414	CHENIKKAYALA ANITHA	✓
15	189L1A0415	CHITTIMENI PURUSHOTHAM	✓
16	189L1A0416	DARISI NITHISH KUMAR	✓
17	189L1A0417	DARLA ASWINI	✓
18	189L1A0418	DASARI MADHURI	✓
19	189L1A0419	DODLA JYOTHIPRAKASH	✗
20	189L1A0420	G RAJASEKHAR	✓
21	189L1A0421	GODUGUNURU KONALIAH	✓
22	189L1A0422	GONDIPALLI VISHNUVARDHAN REDDY	✓

P. I. Jay
HOD

Dept. of ECE
Siddhartha Educational Academy
Group of Institutions
TIRUPATI - 517 505

a

PRINCIPAL
Siddhartha Educational Academy
Group of Institutions
Near C.Gollapalli, Tirupati-517 505



SIDDARTHA EDUCATIONAL ACADEMY GROUP OF INSTITUTIONS (An Integrated Campus for Engineering & MBA) Approved by AICTE, New Delhi & Affiliated to JNTUA, Ananthapuramu, AP. Near C. Gollapalli, Tirupati – 517 505, Andhra Pradesh

23	189L1A0423	GOPALA BHARATH	✓
24	189L1A0424	GOVINDAPPA GARI GIREESH	✓
25	189L1A0425	GUDISI GNANESWAR REDDY	✓
26	189L1A0426	GURRALA SIRAGARI SREENIVASULA REDDY	✓
27	189L1A0427	GUTTA SIRISHA	✓
28	189L1A0428	HANUMANTHARAYAPPA GARI PAVAN	✓
29	189L1A0429	JAYAMPU NAGESH	✓
30	189L1A0430	JEERIGEPALLI KUMAR GARI SASI KUMAR	✓
31	189L1A0431	JOGA VEDAVATHI	✓
32	189L1A0432	JULAPPAGARI ANITHA	✓
33	189L1A0433	K HARIKUMAR REDDY	✓
34	189L1A0434	K MANVITHA	✓
35	189L1A0435	KAMASANI SOMASEKHAR REDDY	✓
36	189L1A0436	KAMBALADINNI SOWJANYA	✓
37	189L1A0437	KANDIGOPULA DEEPA	✓
38	189L1A0438	KASTHURI VENKATA SAI	✓
39	189L1A0439	KATAPPAGARI SASIVARDHAN REDDY	✓
40	189L1A0440	KICHHAGARI ASHOK KUMAR	✓
41	189L1A0441	KOKKALA YESHWANTH	✓
42	189L1A0442	KOMMINENI GIRISH BABU	✓
43	189L1A0443	KONANGI PAVAN KUMAR	✓
44	189L1A0444	LAKKI REDDY MADHAVA REDDY	✓
45	189L1A0445	LAKKIREDDYPALLI BHARGAV	✓
46	189L1A0446	LINGAMDINNE SUMATHI	✓
47	189L1A0447	M BABYSHALINI	✓

P. Kalyan
Dept. of ECE
Siddhartha Educational Academy
Group of Institutions
TIRUPATI - 517 505

✓
PRINCIPAL
Siddhartha Educational Academy
Group of Institutions
Near C.Gollapalli, Tirupati-517 505



SIDDARTHA EDUCATIONAL ACADEMY GROUP OF INSTITUTIONS (An Integrated Campus for Engineering & MBA) Approved by AICTE, New Delhi & Affiliated to JNTUA, Ananthapuramu, AP. Near C. Gollapalli, Tirupati – 517 505, Andhra Pradesh

48	189L1A0448	MAMIDI KRISHNA CHAITHANYA	✓
49	189L1A0449	MAMIDI PRASAD	✓
50	189L1A0450	MANGAPURAM PUNEETH	✓
51	189L1A0451	MANGIRA VISHNU TEJA	✓
52	189L1A0452	MITTAPALLI CHINNELA	✓
53	189L1A0453	MORINTAM NAVEEN REDDY	✓
54	189L1A0454	MUDE TEJA	✓
55	189L1A0455	MUMMIREDDYGARI DIVYA SREE	✓
56	189L1A0456	MUNDLA REDDY RANI	✓
57	189L1A0457	MUNDRE LAHARI	✓
58	189L1A0458	MURALI VAJRALA	✓
59	189L1A0459	NIMMANAPALLI SUSHMITHA	✓
60	189L1A0460	NOOKALA DEEPA	✓
61	189L1A0487	TERE GAYATHRI	✓
62	189L1A0488	THOPUGUNTA MAHESH	✓
63	189L1A0489	THUMMALA VAMSIPRAKASH	✓
64	189L1A0490	THUMMISETTY VENKATA SUJITHA	✓
65	179L5A0402	AMBARAPU RAJIYA	✓
66	179L5A0403	BANDARU LEKHANA	✓
67	179L5A0404	BANDI BALAKUMAR	✓
68	179L5A0405	BODIREDDY MAMATHA	✓
69	179L5A0406	BUSAGANI NIRANJAN	✓
70	179L5A0407	CHANDRAGIRI VINAY KUMAR	✓
71	179L5A0408	CHIGURUPATI PRATHIBHA KUMARI	✓
72	179L5A0409	CHOKKA REDDY GARI SWETHA	✓
73	179L5A0410	D SWAROOPA	✓

P. Sany
HOD
Dept. of ECE
Siddhartha Educational Academy
Group of Institutions
TIRUPATI - 517 505

g
PRINCIPAL
Siddhartha Educational Academy
Group of Institutions
Near C.Gollapalli, Tirupati-517 505



SIDDARTHA EDUCATIONAL ACADEMY GROUP OF INSTITUTIONS (An Integrated Campus for Engineering & MBA) Approved by AICTE, New Delhi & Affiliated to JNTUA, Ananthapuramu, AP. Near C. Gollapalli, Tirupati – 517 505, Andhra Pradesh

74	179L5A0411	GANJI MUNIDILEEP KUMAR	✓
75	179L5A0412	GOPIDINNE NAVEENA	✓
76	179L5A0413	I THEJASRI	✓
77	179L5A0414	IPU JAGADEESH	✓
78	179L5A0415	KAALA SUMALATHA	✓
79	179L5A0416	KADIRI KULLAYAMMA	✓
80	179L5A0417	KALIKIRI MAHALAKSHMI	✓
81	179L5A0418	KOLLURU HEMALATHA	✓
82	179L5A0419	KOTHAGANDLA DAYASAGAR	✓
83	179L5A0420	MUTHYALA NARESH KUMAR	✓
84	179L5A0421	P YAMINI	✓
85	179L5A0422	POOLA VAMSI KRISHNA RAJU	✓
86	179L5A0423	PUTTUR SRINIVAS TEJA	✓
87	179L5A0424	RAGAMSETTI DEEPTHI	✓
88	179L5A0426	SUVVALA SRILATHA	✓
89	179L5A0427	THAMMI SETTI ARCHANA	✓
90	179L5A0428	X MARIA SOFIYA	✓

PRINCIPAL
Siddhartha Educational Academy
Group of institutions
Near C.Gollapalli, Tirupati-517 505

HOD
HOD
Dept. of ECE
Siddhartha Educational Academy
Group of Institutions
TIRUPATI - 517 505



Date:01-02-2019

Summary Report for Two Days Workshop

The two day's Workshop on "Advances in COMMUNICATION SYSTEMS" was organized by Electronics and Communication Engineering Department with associate with JNTUA Ananthapuramu, AP. The event was schedule on 30th and 31th January 2019. A total of 95 participants comprising principal, Head of the department, faculty members and students attend the program.

The program started at 10:00 am with prayer song by Ms. K Divya and team II ECE students followed by welcome address by Mr.T. Venkata Ramana Assistant Professor, Department of ECE to resource person and participants and Mr. P Sai Prasad, Head, Department of ECE introduced resource persons.

The Day -1 session is handover to the Guest Speaker Mrs. G. Mamatha, ASSOCIATE PROFESSOR,, Dept of ECE. JNTUA, Ananthapuramu, AP. ..She explains about Advances in communication systems. She explains clearly about wireless communications technologies like Bluetooth which is useful for below 10 meters and Wi-Fi which is useful up to 100 meters.

The next session begin with modulation techniques, which encourage participants towards mobile communication. He explains about working of mobile communications. The Day -1 session is ended at 3:50 pm

The Day – 2 sessions is continued by the guest speaker Mrs. G. Mamatha, ASSOCIATE PROFESSOR,, Dept of ECE. JNTUA, Ananthapuramu, AP. In this session, she was deeply explained about the concepts time division multiplexing and frequency division multiplexing. .

In the later sessions she discussed multiple access techniques like TDMA, FDMA & CDMA. She also explained about carrier sence multiple access techniques .At last she discussed about how the communication systems are developed now a days.

PRINCIPAL
Siddhartha Educational Academy
Group of Institutions
Near C.Gollapalli, Tirupati-517 505



**SIDDARTHA EDUCATIONAL ACADEMY GROUP OF INSTITUTIONS (An
Integrated Campus for Engineering & MBA) Approved by AICTE, New Delhi &
Affiliated to JNTUA, Ananthapuramu, AP. Near C. Gollapalli, Tirupati – 517 505,
Andhra Pradesh**

In the interactive session, the queries and clarification of the participants were addressed by the resource person. The participant has been given the feedback about the Day – 1 and Day - 2 sessions.

The session is ended with the vote of thanks by Mr. D. Vijayakumar Reddy Assistant Professor, Department of ECE.

Finally we closed this workshop program with National Anthem.

More than 95 participants were benefited from the workshop.

HOD / ECE
HOD
Dept. of ECE
Siddhartha Educational Academy
Group of Institutions
TIRUPATI - 517 505

PRINCIPAL
Siddhartha Educational Academy
Group of Institutions
Near C.Gollapalli, Tirupati-517 505



SIDDARTHA EDUCATIONAL ACADEMY GROUP OF INSTITUTIONS
(An Integrated Campus for Engineering & MBA)
Approved by AICTE, New Delhi & Affiliated to JNTUA, Ananthapuramu, AP.
Near C. Gollapalli, Tirupati – 517 505, Andhra Pradesh

Request letter

Date: 25.01.2019

From

The Head
Department of the CSE
SEAGI, Tirupati

To

The Principal
SEAGI, Tirupati

Respected Sir,

Sub: Request for approval to conduct a seminar on “Emerging Trends in IT Industries ”. – reg

We are planning to conduct a seminar on “Emerging Trends in IT Industries” for the final year students. So, we request you to give permission to conduct the seminar on 29.01.2019

Thanking you

Yours sincerely,

HOD
Dept. of CSE
Siddhartha Educational Academy
Tirupati, 517 505

SIDDARTHA EDUCATIONAL ACADEMY GROUP OF INSTITUTIONS

(An Integrated Campus for Engineering & MBA)

**Approved by AICTE, New Delhi & Affiliated to JNTUA, Ananthapuramu, AP.
Near C. Gollapalli, Tirupati – 517 505, Andhra Pradesh**



File No: SEAGI/CSE/Seminar/2018-2019

Circular

Date: 25.01.2019

The Department of Computer Science and Engineering is organizing for a seminar “**Emerging Trends in IT Industries**” for the students of IV B.Tech CSE. All the students of IV B.Tech CSE are hereby informed to register for seminar on or before 28.01.2019. The coordinator for the workshop is Mr. N. Anand Reddy, Asst Professor, Department of CSE.

Venue: CSE seminar Hall

Date:29.01.2019

Timings: 9:30 am onwards

HoD /CSE

Dept. of CSE
Siddhartha Educational Academy
Group of Institutions
TIRUPATI - 517 505

Principal

PRINCIPAL
Siddhartha Educational Academy
Group of Institutions
Near C.Gollapalli, Tirupati-517 505



SIDDARTHA EDUCATIONAL ACADEMY GROUP OF INSTITUTIONS
(An Integrated Campus for Engineering & MBA)
Approved by AICTE, New Delhi & Affiliated to JNTUA, Ananthapuramu, AP.
Near C. Gollapalli, Tirupati

Seminar on

Emerging Trends in IT Industries.

Resource Person

Mr. Venkataraman
Senior Faculty
CADD Centre, Tirupati

Date: 29.01. 2019

Venue: CSE- Seminar Hall

Organized by
Department of Computer Science and Engineering



SIDDARTHA EDUCATIONAL ACADEMY GROUP OF INSTITUTIONS
(An Integrated Campus for Engineering & MBA)
Approved by AICTE, New Delhi & Affiliated to JNTUA, Ananthapuramu, AP.
Near C. Gollapalli, Tirupati – 517 505, Andhra Pradesh

Date: 29.01.2019

Computer Science and Engineering Department

Summary Report – Seminar

The one day Seminar was conducted on 'Emerging Trends in IT Industries' on 29.01.2019 for Final year students. Totally 32 students were participated in the event. The main Objective of this event is to given better skills on Latest Trends tools used in the industries. The program was planned as one session conducted at the Computer Lab. HOD had inaugurated the workshop and exposes the importance of workshop. The resource person Mr. Venkataraman from CADD Centre, Tirupati. He delivered the content of Introduction about IT Industries and how the latest tools they were using in their company. Some of the Latest trends in the current trends like Cloud Computing, Mobile Application, User Interfaces and Analytics. The following topics were covered in the workshop. Cloud Computing use, Mobile Application Tools, User Interface tools and Analytics of the problem.



HoD /CSE

Dept. of CSE

Siddhartha Educational Academy
Group of Institutions
TIRUPATI - 517 505

SIDDARTHA EDUCATIONAL ACADEMY GROUP OF INSTITUTIONS

(An Integrated Campus for Engineering & MBA)
Approved by AICTE, New Delhi & Affiliated to JNTUA, Ananthapur
Near C. Gollapalli, Tirupati – 517 505, Andhra Pradesh

Computer Science and Engineering Department

**Seminar on
Emerging Trends in IT Industries**

Event Photos

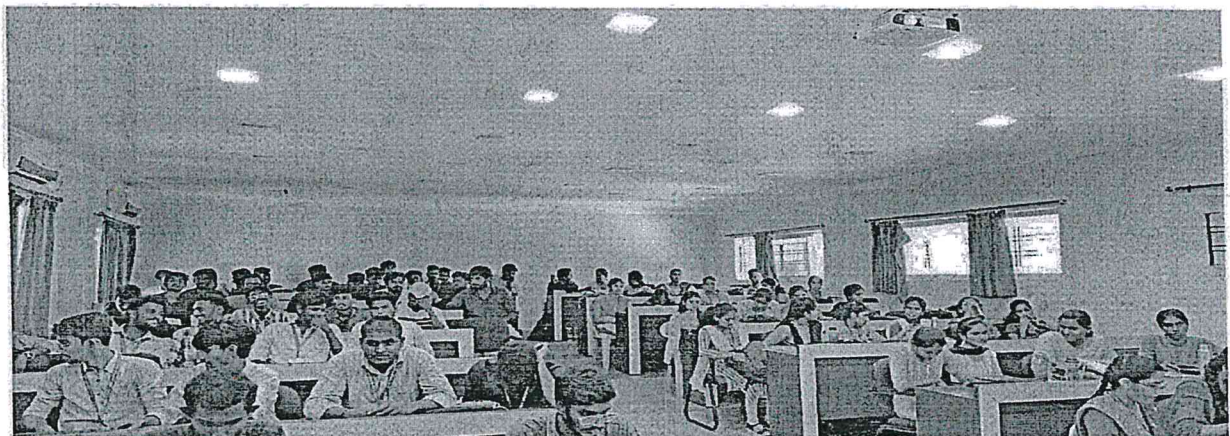

students attended the presentation

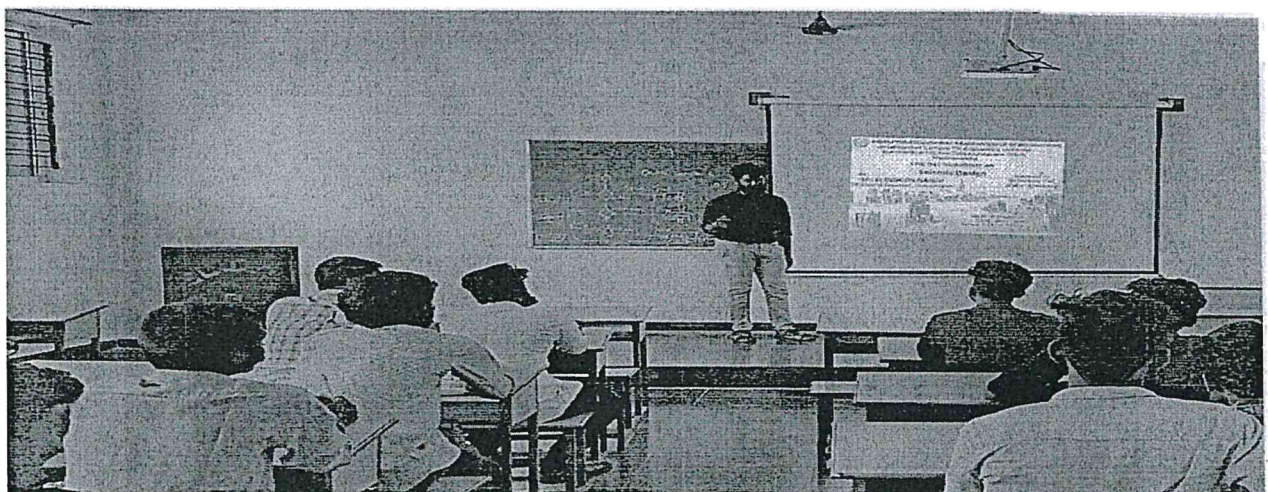

Resource person presentation



SIDDARTHA EDUCATIONAL ACADEMY GROUP OF INSTITUTIONS

(An Integrated Campus for Engineering & MBA)

Approved by AICTE, New Delhi & Affiliated to JNTUA, Ananthapur

Near C. Gollapalli, Tirupati – 517 505, Andhra Pradesh

Computer Science and Engineering Department

Seminar on
Emerging Trends in IT Industries

Attendance Sheet – 29.01.2019

S.No	Roll No.	Name of the Students	Class & Branch	Attendance
1.	159L1A0502	AAKULETI YATHEESHA	IV CSE	A. Yatheesha
2.	159L1A0503	ALLU CHAITHANYA	IV CSE	Allu chaithanya
3.	159L1A0504	AMBU NANDINI	IV CSE	A. Vandini
4.	159L1A0505	AMBU SAMPATH KUMAR REDDY	IV CSE	A. Sampath Kumar Reddy
5.	159L1A0506	ANNAMALAMUDI DURGA	IV CSE	A. Durga
6.	159L1A0507	ARI SAIPRASANTHI	IV CSE	A. Saiprasanthi
7.	159L1A0508	ARIKELA ALEKHYA	IV CSE	A. Alekhya
8.	159L1A0509	AVULA BHAVANKUMAR REDDY	IV CSE	A. Bhavanakumar reddy.
9.	159L1A0510	B RAMYA	IV CSE	B. Ramya
10.	159L1A0511	BANAVATH BHARGAVI	IV CSE	B. Bhargavi
11.	159L1A0517	CHIRUTHANI	IV CSE	Chiruthani

		MUNENDRA		munendra .
12.	159L1A0518	DASARARAJU POOJITHA	IV CSE	P. Poojitha
13.	159L1A0520	E MADHURI	IV CSE	E. Madhuri
14.	159L1A0521	ENUGULA MAHITHA	IV CSE	E. Mahitha
15.	159L1A0522	G NAVYA	IV CSE	G. Abhyaya.
16.	159L1A0523	G SIREESHA	IV CSE	G. Sireesha
17.	159L1A0525	GERIKETI CHANDU	IV CSE	G. Chandu .
18.	159L1A0527	GUNDRE SUSMITHA	IV CSE	G. Susmitha
19.	159L1A0530	KAYAM ARAVINDH SAI	IV CSE	K. Aravindh sai.
20.	159L1A0532	KONDURU AKSHAYA	IV CSE	K. Akshaya
21.	159L1A0533	KONNAIAH GARI PRIYANKA	IV CSE	K. Priyanka
22.	159L1A0539	MADDINI NAVEENA	IV CSE	M. Naveena.
23.	159L1A0540	MANNURU JAYASREE	IV CSE	M. Jayasree .
24.	159L1A0544	MINNAMAREDDY SRAVANI	IV CSE	M. Sravani
25.	159L1A0546	MUMMIREDDIGARI SIREESHA	IV CSE	M. Sireesha
26.	159L1A0547	MUMMIREDDYGARI LALATHI	IV CSE	M. Lalathi
27.	159L1A0549	NANDHANURU VENUGOPAL	IV CSE	N. Venugopal
28.	159L1A0550	O P RAJITHA	IV CSE	OP Rajitha

29.	159L1A0560	RACHETTY GOUTHAMI	IV CSE	R. gouthami
30.	159L1A0561	RAMAGIRI NAGESH BABU	IV CSE	A
31.	159L1A0562	RAMIREDDY VANI	IV CSE	R. Vani
32.	159L1A0564	S DILEEP KUMAR	IV CSE	S. Dileep Kumar.
33.	159L1A0565	S DILLI RANI	IV CSE	S. Rani
34.	159L1A0566	SANDRA SAI KUMAR	IV CSE	S. saikumar
35.	159L1A0567	SHAIK FAZIYA BEGUM	IV CSE	S. faziya Begum
36.	159L1A0569	SYKAM HARIPRIYA	IV CSE	S. Harini Priya
37.	159L1A0570	THURAKA SANTHOSH TEJA REDDY	IV CSE	A
38.	159L1A0572	TOORPINTI UMAMAHESWARI	IV CSE	T. Uma maheswari
39.	159L1A0574	UGGRARAPU NAVEEN KUMAR	IV CSE	U. naveen kumar
40.	159L1A0576	V BHARGAVI	IV CSE	A



HOD
Dept. of CSE
Siddartha Educational Academy
Group of Institutions
TIRUPATI - 517 505

BANNER OF EVENT



SIDDARTHA EDUCATIONAL ACADEMY GROUP OF INSTITUTIONS
(An Integrated Campus for Engineering & MBA)

Approved by AICTE, New Delhi & Affiliated to JNTUA, Ananthapuramu,
AP.

Near C. Gollapalli, Tirupati – 517 505, Andhra Pradesh

WORKSHOP ON

APPLICATIONS OF NANO MATERIALS

ORGANIZED BY Dept.of BS&H

SPEAKER
Mrs.V.BEBI

Date: 21/01/2019
Time: 09:00 AM
Venue: E-CLASS ROOM

CONVENER
Dr.P.RAVI
HOD
BS&H

HOD
Dept. of H & S
Siddhartha Educational Academy
Group of Institutions
TIRUPATI - 517 505



SIDDARTHA EDUCATIONAL ACADEMY GROUP OF INSTITUTIONS

(An Integrated Campus for Engineering & MBA)

Approved by AICTE, New Delhi & Affiliated to JNTUA, Ananthapuramu, AP.

Near C. Gollapalli, Tirupati – 517 505, Andhra Pradesh

SEAGI/PERMISSION/BASIC SCIENCES /2019

Date: 18/01/19

Permission Letter

To

The Principal,

SEAGI,

Tirupati.

Sub: Permission for Conducting one day workshop on ‘**APPLICATIONS OF NANO-MATERIALS**’ in our college

Respected sir,

With reference to the subject cited above, **BASIC SCIENCES** intends to conduct an one day workshop on ‘**APPLICATIONS OF NANO-MATERIALS**’ by **V. Bebi** in our college on 21/01/19. Therefore, I request you to kindly grant us permission to make the necessary arrangements and conduct the program successfully.

Thanking you sir,

Yours Sincerely,

CONVENER

yes
PRINCIPAL
Siddhartha Educational Academy
Group of Institutions
TIRUPATI - 517 505



SIDDARTHA EDUCATIONAL ACADEMY GROUP OF INSTITUTIONS
(An Integrated Campus for Engineering & MBA)
Approved by AICTE, New Delhi & Affiliated to JNTUA, Ananthapuramu, AP.
Near C. Gollapalli, Tirupati – 517 505, Andhra Pradesh

SEAGI/CIR/ BASIC SCIENCES /2019

Date: 19/01/2019

Circular

This is to inform the I.B.TECH students and faculty of all the branches that department of BASIC SCIENCES is conducting an one day workshop on ‘**APPLICATIONS OF NANO-MATERIALS**’ by **V. Bebi** in our college on 21/01/2019 to introduce Nano - materials and its applications to students. Therefore, all of you requested to register for the program.

CONVENER

Copy to:

1. The Notice Board
2. The File



SIDDARTHA EDUCATIONAL ACADEMY GROUP OF INSTITUTIONS

(An Integrated Campus for Engineering & MBA)

Approved by AICTE, New Delhi & Affiliated to JNTUA, Ananthapuramu, AP.

Near C. Gollapalli, Tirupati – 517 505, Andhra Pradesh

Summary

Date: 21/01/2019

The program began at 9.00 in the morning. All the registered students and faculty members gathered in the seminar hall. Initially, Principal Prof. K. Rajasekhar addressed the students and faculty members.

The presentation on ‘Applications of Nano-Materials began at 10 A.M, by Mrs. V. Bebi. She firstly, defined Nano Materials and focussed on its applications. She also emphasised on the applications of Nano Materials in the areas of Electronics, Energy, Biomedicine, Environment, Food, and textile industry. The speaker also spoke about the ongoing research in the field of Nano Materials.

At 1.00 PM lunch break was given to all. After the lunch break all gathered again. In the afternoon session the speaker, Mrs. V. Bebi clarified the doubts of the students. In the end, all faculty members felicitated the speaker and finally the program concluded with a vote of thanks proposed by Mrs. K. Deepika, faculty of Chemistry.

HOD

Dept. of H & S

Siddhartha Educational Academy

Group of Institutions

TIRUPATI - 517 505

WORKSHOP ON "APPLICATIONS OF NANO MATERIALS" HELD ON 18/01/2019

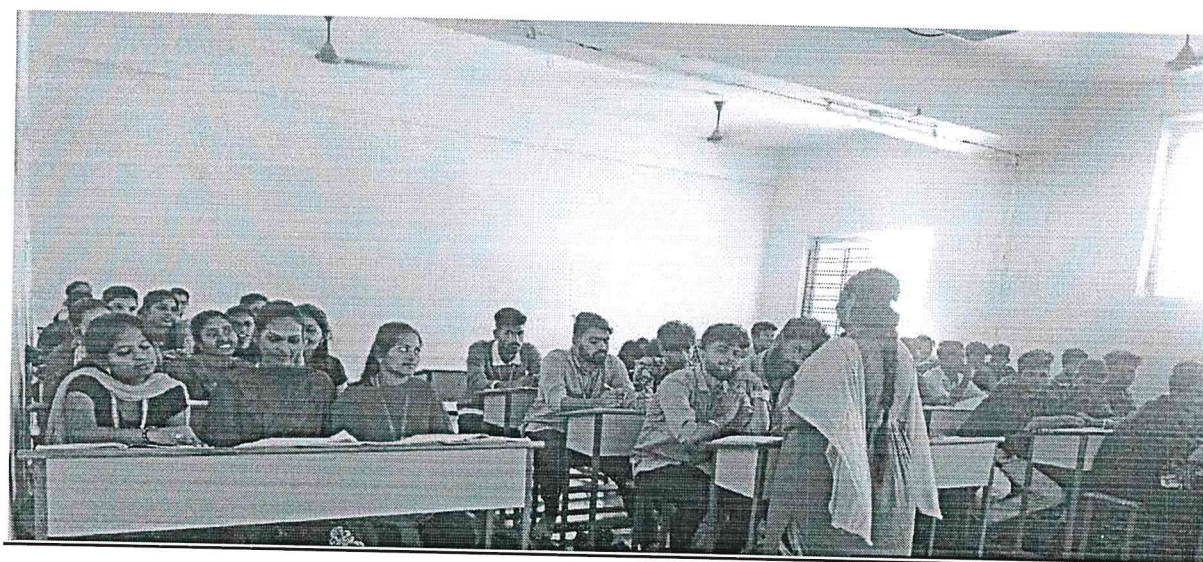
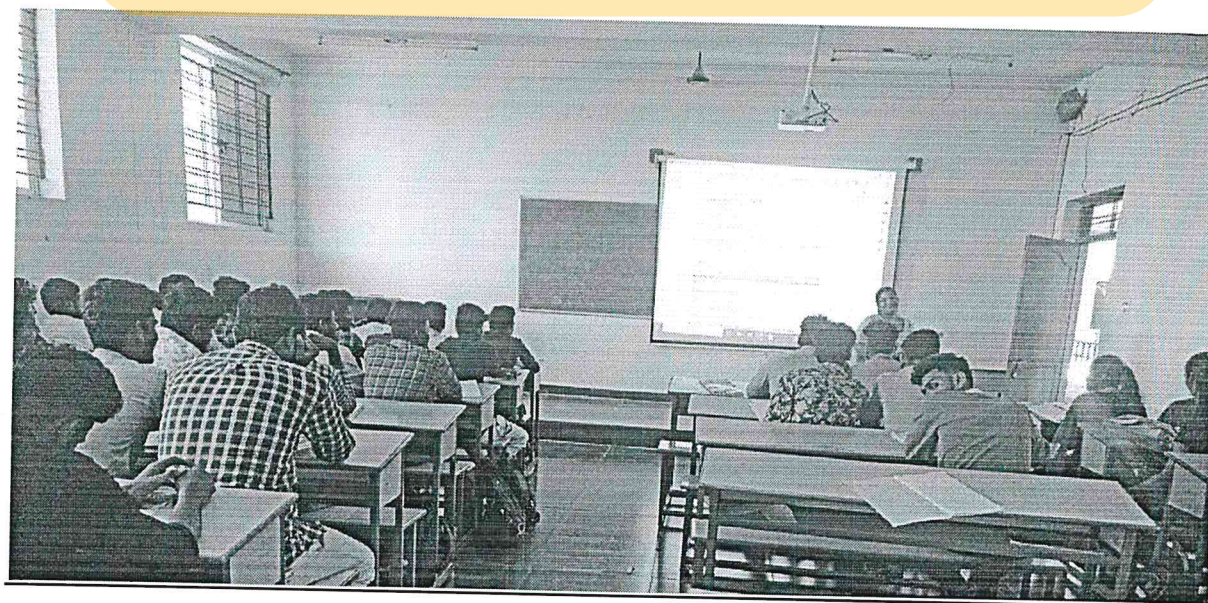

Resource person presentation

HOD
Dept. of H & S
Siddarth Educational Academy
Group of Institutions
TIRUPATI - 517 505



SIDDARTHA EDUCATIONAL ACADEMY GROUP OF INSTITUTIONS
(An Integrated Campus for Engineering & MBA)
Approved by AICTE, New Delhi & Affiliated to JNTUA, Ananthapuramu, AP.
Near C. Gollapalli, Tirupati – 517 505, Andhra Pradesh

REF : SEAGI/CIVIL/2018

Request letter

Date: 24/10/2018

From,

K. GOPI KRISHNA

HOD-CIVIL

SEAGI

Tirupati-517505

To,

The Principal

SEAGI

Tirupati-517505

Respected sir,

SUB: Requesting permission for conducting workshop regarding

We are planned to conduct one day work shop on “STRUCTURAL AND FOUNDATION ANALYSIS” for the faculty and students to enhance their knowledge in Recent Trends. I kindly request you to grant permission to conduct workshop on 27/10/2018.

Thanking you sir

Yours sincerely

K. G. Krishna
HOD-CIVIL 24/10/2018

(K. GOPI KRISHNA)
HOD

Dept. of Civil Engineering
Siddhartha Educational Academy
Group of Institutions
TIRUPATI - 517 505

K
PRINCIPAL
Siddhartha Educational Academy
Group of Institutions
Near C. Gollapalli, TIRUPATI-517 505



SIDDARTHA EDUCATIONAL ACADEMY GROUP OF INSTITUTIONS

(An Integrated Campus for Engineering & MBA)

**Approved by AICTE, New Delhi & Affiliated to JNTUA, Ananthapuramu, AP.
Near C. Gollapalli, Tirupati – 517 505, Andhra Pradesh**

Date: 25/10/2018

Circular

All the staff of SEAGI are hereby informed that Civil engineering department is organizing a one day workshop on “STRUCTURAL AND FOUNDATION ANALYSIS” by Mrs. S. MOUNIKA, Structural Engineer, Quest Global, on 27/10/2018. So all the staff are instructed to attend the program without fail.

Venue: SEAT E-classroom

Timings : 10.00 am to 1.00 pm

HoD / CIVIL 25/10/2018
HOD

Dept. of Civil Engineering
Siddhartha Educational Academy
Group of institutions
TIRUPATI - 517 505

Principal

PRINCIPAL
Siddhartha Educational Academy
Group of Institutions
Near C. Gollapalli, TIRUPATI-517 505

BANNER OF EVENT



SIDDARTHA EDUCATIONAL ACADEMY GROUP OF INSTITUTIONS

An Integrated Campus for Engineering and MBA

Approved by AICTE, New Delhi & Affiliated to JNTUA,

Ananthapuramu

ONE DAY WORKSHOP ON

Structural and Foundation Analysis

By

Mrs. S.Mounika

STRUCTURAL ENGINEER, QUEST GLOBAL

Organized By

Department of
Civil Engineering

DATE:27/10/2018

TIME:: 10:00 AM

VENUE: E CLASS ROOM

PRINCIPAL
Siddhartha Educational Academy
Group of Institutions
Near C. Gollapalli, TIRUPATI-517 505

PHOTOS OF WORKSHOP EVENT

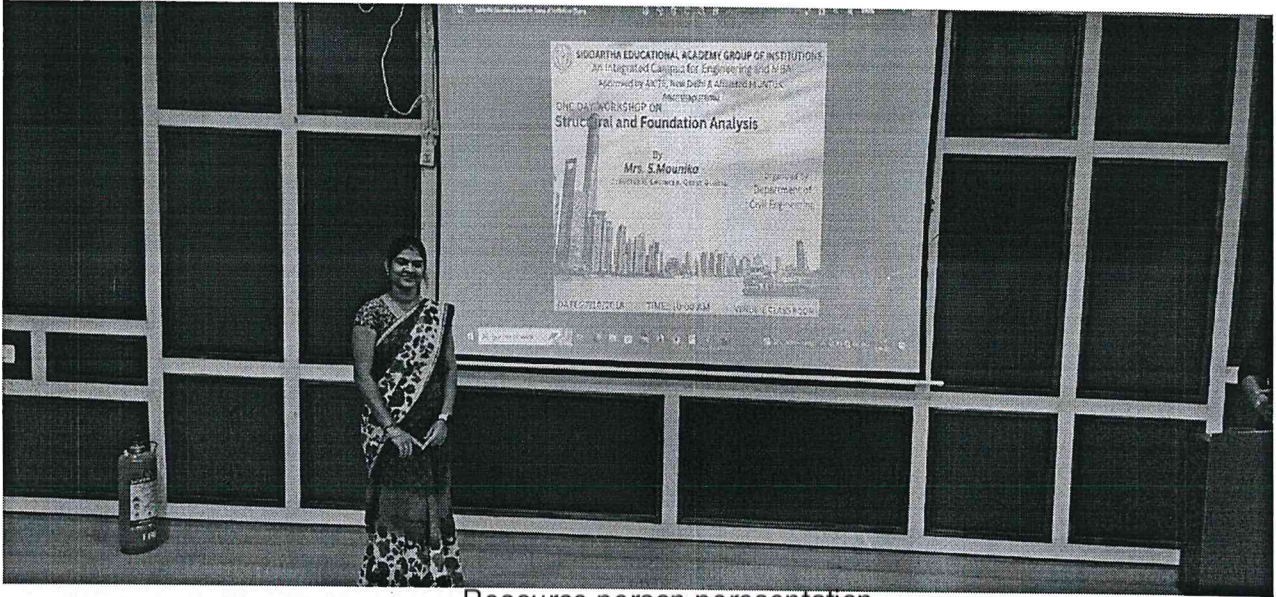

Resource person presentation



4
PRINCIPAL
Siddhartha Educational Academy
Group of Institutions
Near C. Gollapalli, TIRUPATI-517 505

SIDDARTHA EDUCATIONAL ACADEMY GROUP OF INSTITUTIONS
(An Integrated Campus for Engineering & MBA)
Approved by AICTE, New Delhi & Affiliated to JNTUA, Ananthapuramu, AP.
Near C. Gollapalli, Tirupati – 517 505, Andhra Pradesh

Civil Engineering Department

Summary Report of one day Workshop

The one day Workshop on “STRUCTURAL AND FOUNDATION ANALYSIS” was organized by Department of **Civil Engineering**. The event was schedule on 27/10/2018. A total of 80 participants comprising principal, Head of the civil department, faculty members of all departments attend the program.

The program started at 10:00 am with prayer song by Ms. P. Roopasri, Assistant Professor, Department of CIVIL, followed by welcome address by Mr. S. Vinodh Kumar, Assistant Professor, Department of CIVIL to resource person and participants , Mr. K. Gopi Krishna, Head, Department of CIVIL introduced by resource person.

The session is handover to the Guest Speaker Mrs. S. MOUNIKA, Structural Engineer, Quest Global, he explains about “STRUCTURAL AND FOUNDATION ANALYSIS” . Structural engineering is the field of engineering particularly concerned with the design of economical and efficient load-bearing structures. Within the civil engineering, it is largely the implementation of mechanics to the design of the large structures that are fundamental to basic living, such as buildings, bridges, walls, dams, and tunnels. Structural engineers need to design structures that do not collapse or behave in undesirable ways while serving their useful functions. Structural design is the process of determining location, material, and size of structural elements to resist forces acting in a structure. A structure essentially consists of two parts, namely the super structure which is above the plinth level and the substructure which is below the plinth. Substructure is also known as the foundation and this forms the base for any structure. The soil on which the foundation rests is called the “foundation soil”.

In the interactive session, the queries and clarification of the participants were addressed by the resource person. The participants has been given the feedback about the session

The session is ended with the vote of thanks by Mr K. Raja Assistant Professor, Department of CIVIL

Finally we closed this workshop program with National Anthem.

More than 80 participants were benefited from the workshop.

PRINCIPAL
Siddhartha Educational Academy
Group of Institutions
Near C. Gollapalli, TIRUPATI-517 505

HoD / CIVIL
HOD
Dept. of Civil Engineering
Siddhartha Educational Academy
Group of Institutions
TIRUPATI - 517 505



SIDDARTHA EDUCATIONAL ACADEMY GROUP OF INSTITUTIONS
(An Integrated Campus for Engineering & MBA)
Approved by AICTE, New Delhi & Affiliated to JNTUA, Ananthapuramu, AP.
Near C. Gollapalli, Tirupati – 517 505, Andhra Pradesh

REF : SEAGI/MECH/2018

Request letter

Date 20/08/2018

From,

D.Mallikarjuna reddy
HOD-MECHANICAL
SEAGI
Tirupati-517505

To,

The Principal
SEAGI
Tirupati-517505

Respected sir,

SUB: Requesting permission for conducting seminar regarding

We are planned to conduct one day seminar on “ ADVANCED MANUFACTURING PROCESSES” for the faculty and students of MECH to enhance their knowledge in Recent Trends. I kindly request you to grant permission to conduct Guest Lecture on 21 st August 2018.

Thanking you sir

I/c S. Shankar 20/8/18

Yours sincerely

HOD-MECH

(D.Mallikarjuna Reddy)

HOD
Dept. of ME
Siddhartha Educational Academy
Group of Institutions
TIRUPATI - 517 505

br
PRINCIPAL
Siddhartha Educational Academy
Group of Institutions
Near C. Gollapalli, TIRUPATI-517 505



SIDDARTHA EDUCATIONAL ACADEMY GROUP OF INSTITUTIONS

(An Integrated Campus for Engineering & MBA)

Approved by AICTE, New Delhi & Affiliated to JNTUA, Ananthapuramu, AP.

Near C. Gollapalli, Tirupati – 517 505, Andhra Pradesh

Date: 20/08/2018

Circular

All the staff and students of MECH are hereby informed that Mechanical engineering department is organising a one day seminar on “ADVANCED MANUFACTURING PROCESSES” by PROF.J.UDAY PRAKASH VELTECH,AVADI on 21/08/2018 .So all the staff and students of MECH are instructed to attend the program without fail.

Venue: SEAT E-classroom

Timings : 9.00 am to 1.00 pm

T/c S. Shankar 20/8/2018
HoD / MECH

HOD
Dept. of ME
Siddhartha Educational Academy
Group of Institutions
TIRUPATI - 517 505

[Signature]
Principal
PRINCIPAL
Siddhartha Educational Academy
Group of Institutions
Near C. Gollapalli, TIRUPATI-517 505

BANNER OF EVENT

SIDDARTHA EDUCATIONAL ACADEMY
GROUP OF INSTITUTIONS

C-GOLLAPALLI - TIRUPATI

A SEMINAR ON
"ADVANCED MANUFACTURING PROCESSES"

BY

PROF. J. UDAY PRAKASH

VELTECH - AVADI

ON

21 AUG 2018

CONDUCTED BY DEPT. OF MECHANICAL ENGINEERING

FROM 09.00 AM TO 01.00 PM
VENUE: E-CLASS ROOM - SEAT

PRINCIPAL
Siddhartha Educational Academy
Group of Institutions
Near C. Gollapalli, TIRUPATI-517 505

PHOTOS OF EVENT



Presentation of Guest lecturer



Attendees of event

PRINCIPAL
Siddartha Educational Academy
Group of Institutions
Near C. Gollapalli, TIRUPATI-517 505



SIDDARTHA EDUCATIONAL ACADEMY GROUP OF INSTITUTIONS
(An Integrated Campus for Engineering & MBA)
Approved by AICTE, New Delhi & Affiliated to JNTUA, Ananthapuramu, AP.
Near C. Gollapalli, Tirupati – 517 505, Andhra Pradesh

Mechanical Engineering Department

Summary Report of one day SEMINAR

The one day SEMINAR on “ADVANCED MANUFACTURING PROCESSES” was organized by Department of **Mechanical Engineering**. The event was scheduled on 21/08/2018. A total of 90 participants comprising principal, Head of the Mechanical department, faculty members and students of MECH department attend the program.

The program started at 09:00 am with prayer song by Mr.G.Babu Prasad, Assistant Professor, Department of MECH, followed by welcome address by Mr.G.Narendranath Assistant Professor, Department of MECH to resource person and participants, Mr.D.Mallikarjuna Reddy, Head, Department of MECH introduced by resource person.

The session is handed over to the Guest Speaker PROF.J.UDAY PRAKASH VELTECH, AVADI he explains about “ADVANCED MANUFACTURING PROCESSES” **Advanced manufacturing** is the use of innovative technology to improve products or processes, with the relevant technology being described as advanced, innovative or cutting edge. Advanced manufacturing industries increasingly integrate new innovative technologies in both products and processes. The rate of technology adoption and the ability to use that technology to remain competitive and add value to define the advanced manufacturing sector.

World class manufacturing (WCM) integrates the latest-generation machinery with process/work systems to facilitate manufacturing based business development governed around manufactured products only, duly based over a high accent on product substitution or new product development.

Advanced manufacturing centers upon improving the performance of US industry through the innovative application of technologies, processes and methods to product design and production.

In the interactive session, the queries and Guest Lecture clarification of the participants were addressed by the resource person. The participants have been given the feedback about the session.

The session is ended with the vote of thanks by Mr D.Dinesh Assistant Professor, Department of MECH

Finally we closed this workshop program with National Anthem.

More than 85 participants were benefited from the SEMINAR

S. Shankar
HoD / MECH

a
PRINCIPAL
Siddhartha Educational Academy
Group of Institutions
Near C. Gollapalli, TIRUPATI-517 505

HOD
Dept. of ME
Siddhartha Educational Academy
Group of Institutions
TIRUPATI - 517 505

BANNER OF EVENT



SIDDARTHA EDUCATIONAL ACADEMY GROUP OF INSTITUTIONS
(An Integrated Campus for Engineering & MBA)
Approved by AICTE, New Delhi & Affiliated to JNTUA, Ananthapuramu,
AP.

Near C. Gollapalli, Tirupati – 517 505, Andhra Pradesh

WORKSHOP ON

ROLE OF MATHEMATICS IN ENGINEERING

ORGANIZED BY Dept.of BS&H

SPEAKER
Dr.P.RAVI

Date: 20/08/2018
Time: 10:00 AM
Venue: SEMINAR HALL (118)

CONVENER
Dr.P.RAVI
HOD
BS&H

HOD
Dept. of H & S
Siddhartha Educational Academy
Group of institutions
TIRUPATI - 517 505



SIDDARTHA EDUCATIONAL ACADEMY GROUP OF INSTITUTIONS
(An Integrated campus for Engineering & MBA)
Approved by AICTE, New Delhi & Affiliated to JNTUA, Ananthapuramu
Near C. Gollapalli, Tirupati- 517 505, Andhra Pradesh

SEAGI/PERMISSION/BASIC SCIENCES/2018

17/08/2018

Permission Letter

To

The Principal,

SEAT, Tirupati.

Sub: Permission for Conducting one day workshop on 'ROLE OF MATHEMATICS IN ENGINEERING' –reg.

Respected Sir,

With reference to the above subject, BASIC SCIENCES intends to conduct a one day workshop on 'ROLE OF MATHEMATICS IN ENGINEERING' by Dr.P.Ravi in our college on 20/08/2018. Therefore, I request you to kindly grant us permission to make the necessary arrangements and conduct the course successfully.

Thanking you sir,

Yours Sincerely

CONVENER

HOD

Dept. of H & S

Siddhartha Educational Academy

Group of Institutions

TIRUPATI - 517 505

yes
K.P.



SIDDARTHA EDUCATIONAL ACADEMY GROUP OF INSTITUTIONS
(An Integrated Campus for Engineering & MBA)
Approved by AICTE, New Delhi & Affiliated to JNTUA, Ananthapuramu, AP.
Near C. Gollapalli, Tirupati – 517 505, Andhra Pradesh

SEAGI/CIR/ BASIC SCIENCES /2018

Date: 19/08/2018

Circular

This is to inform that all the B. Tech students and faculty of all the branches that department of BASIC SCIENCES is conducting an one day workshop on '**ROLE OF MATHEMATICS IN ENGINEERING**' by **Dr. P. Ravi** in our college to introduce various applications of mathematics in modern technology to students on 20/08/2018. Therefore, all of you requested to register for the program.

CONVENER

Copy to:

1. The Notice Board
- ✓ 2. The File



SIDDARTHA EDUCATIONAL ACADEMY GROUP OF INSTITUTIONS

(An Integrated Campus for Engineering & MBA)

Approved by AICTE, New Delhi & Affiliated to JNTUA, Ananthapuramu, AP.

Near C. Gollapalli, Tirupati – 517 505, Andhra Pradesh

Summary

Date: 20/08/2018

In the morning 10.00 am of the day of workshop all the registered students and faculty members were gathered at e-class room of SEAGI. Initially the principal Dr. K. Raja Sekhar sir started the meeting by welcoming the all students and faculty members. Also he has given a speech on 'how mathematics are playing key role in modern engineering and technology'

At the 11.00 pm Dr. P. Ravi sir started his presentation on 'ROLE OF MATHEMATICS IN ENGINEERING'. Throughout the presentation he has discussed various applications of mathematics in

- i) Civilengineering (constructions& optimization)
- ii) Mechanical engineering
- iii) Electronic & communication engineering(Fourier series, Laplace transforms& Z- transforms)
- iv) Electrical & Electronics Engineering (first ,second & higher order linear differential equations)
- v) Computer science & engineering(logical gates& posets)

At 1.30 pm lunch break has given to all. After the lunch break all gathered again. In the afternoon session the speaker Dr. P. Ravi sir has cleared the doubts of students, after that all faculty members felicitate the speaker and finally the program has completed by giving vote of thanks by Mrs. K. Thriveni faculty of mathematics.

HOD
Dept. of H & S
Siddhartha Educational Academy
Group of Institutions
TIRUPATI - 517 505

WORKSHOP ON "ROLE OF MATHEMATICS IN ENGINEERING" HELD ON 20/08/2018

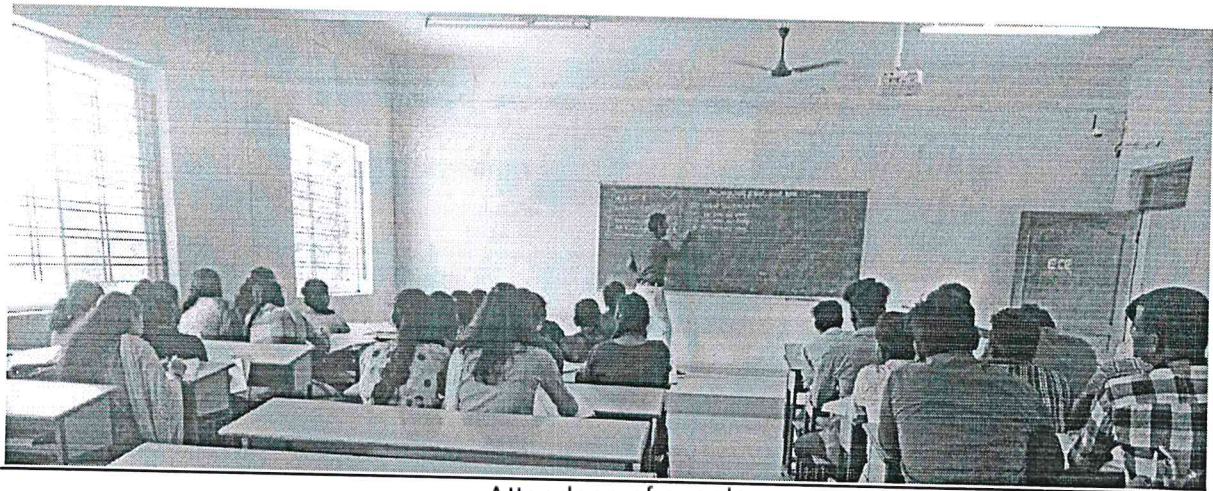
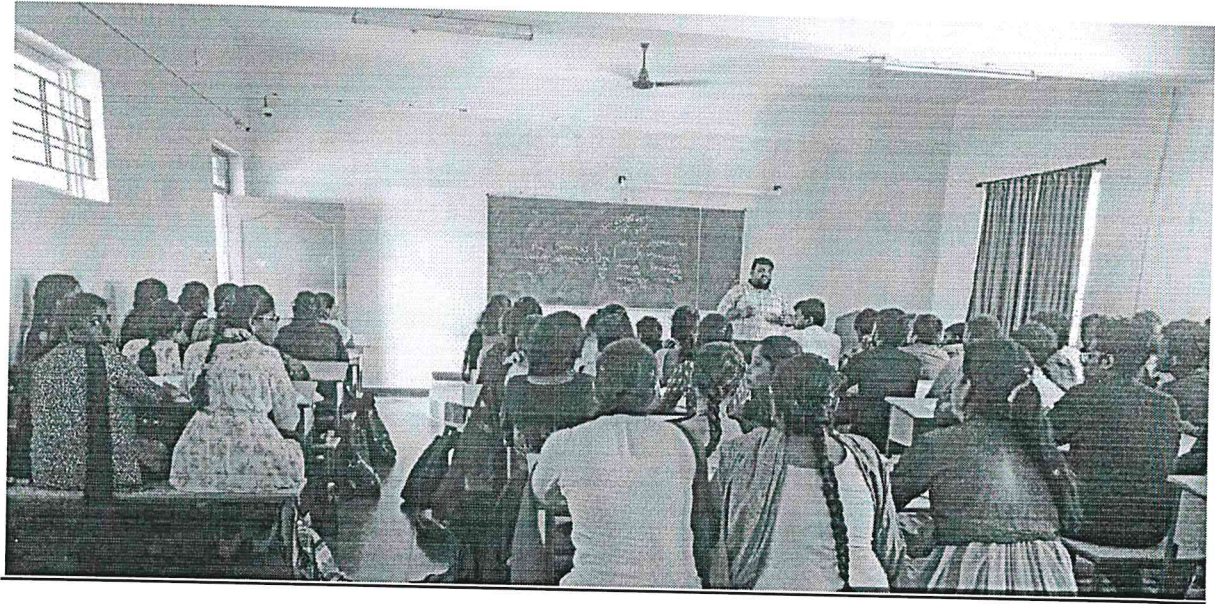

Attendees of events

HOD
Dept. of H & S
Siddharth Educational Academy
Group of Institutions
TIRUPATI - 517 505



SIDDARTHA EDUCATIONAL ACADEMY GROUP OF INSTITUTIONS

(An Integrated Campus for Engineering & MBA)

**Approved by AICTE, New Delhi & Affiliated to JNTUA, Ananthapuramu, AP.
Near C. Gollapalli, Tirupati – 517 505, Andhra Pradesh**

MBA/CIR /WORK SHOP/2019

Date: 06-03-2019

Circular

This is to inform the students of MBA that a Two day Workshop is intended to be organised on the topic “**Soft Skills & Development**” which is scheduled from **11-03-2019 to 12-03-2019**.

Therefore, the students are encouraged to attend the program without fail on the stipulated date.

HOD
Dept. of MBA
Siddhartha Educational Academy
[Department of MBA]
Group of Institutions
TIRUPATI - 517 505

Copy to:

1. The Principal
2. The Director
3. The Faculty
4. The Notice board
5. The File

PRINCIPAL
Siddhartha Educational Academy
Group of Institutions
Near C.Gollapalli, Tirupati-517 505



SIDDARTHA EDUCATIONAL ACADEMY GROUP OF INSTITUTIONS
(An Integrated Campus for Engineering & MBA)
Approved by AICTE, New Delhi & Affiliated to JNTUA, Ananthapuramu, AP.
Near C. Gollapalli, Tirupati – 517 505, Andhra Pradesh

Department of MBA

A Two-Day Workshop on “Softskills & Development “during 11-03-2019 & 12-03-2019
Attendance Sheet

S.No	Register No	Name of the Student	Year	11/3/2019	12/3/2019
1	189L1E0001	A SURESH BABU *	MBA I Year	P	P
2	189L1E0002	ALETI PRASAD	MBA I Year	P	P
3	189L1E0003	ALLAMADUGU KRISHNA REDDY *	MBA I Year	P	P
4	189L1E0004	AMMIREDDY LAKSHMI REDDY	MBA I Year	P	P
5	189L1E0005	ANNAIAHGARI JANAKI	MBA I Year	P	P
6	189L1E0006	ARLA NAGARAJESH *	MBA I Year	P	P
7	189L1E0007	AVULA MALLIKARJUNA	MBA I Year	P	P
8	189L1E0008	BANUGU MANIKANTA	MBA I Year	P	P
9	189L1E0009	BESTA HAREESH	MBA I Year	P	P
10	189L1E0010	BHAGAMMAGARI MANJUNATH	MBA I Year	P	P
11	189L1E0011	BOJJA SUBRAMANYAM	MBA I Year	A	P
12	189L1E0012	BOLLINENI P CHOWDARY	MBA I Year	P	P
13	189L1E0013	BOYAREDDY GARI PRAVEEN	MBA I Year	P	P
14	189L1E0014	BURRA GOWTHAMI	MBA I Year	P	P
15	189L1E0015	C SURESH REDDY	MBA I Year	P	P
16	189L1E0016	CHALLAGUNDLA CHARITH	MBA I Year	P	P
17	189L1E0017	CHICHILI LIKHITHA	MBA I Year	P	P
18	189L1E0018	CHINNABOINA GANGADHARA	MBA I Year	A	P
19	189L1E0019	CHINNIGARI MANOJ	MBA I Year	P	P
20	189L1E0020	DEVARINTI LAKSHMI DEVI	MBA I Year	P	P
21	189L1E0021	DEVARINTI RAMA DEVI	MBA I Year	P	A
22	189L1E0022	DOSAPATI HARSHAVARDHAN	MBA I Year	P	A
23	189L1E0023	EEGA SUKANYA	MBA I Year	P	P
24	189L1E0024	G BALAKRISHNA	MBA I Year	P	P
25	189L1E0025	G GAJENDRA BABU	MBA I Year	P	P
26	189L1E0026	GANDHI VISHNU PRIYA	MBA I Year	P	P
27	189L1E0027	GANGARAJU PAVAN KUMAR	MBA I Year	A	P
28	189L1E0028	GUDI GAYATHRI *	MBA I Year	P	A
29	189L1E0029	GUNDLOORI MOUNICA	MBA I Year	P	P
30	189L1E0030	GUNDLURU MUNISWARI	MBA I Year	P	P
31	189L1E0031	GUNDUPALLI CHANDRASEKHAR	MBA I Year	P	P
32	189L1E0032	GURRAM NAGARJUNA	MBA I Year	P	P
33	189L1E0033	GUVVALA LAKSHMI PRASAD REDDY	MBA I Year	P	P
34	189L1E0034	J REDDAIAH	MBA I Year	P	P

35	189L1E0035	JAMAKALA UPENDRA	MBA I Year	P	P
36	189L1E0036	K LAKSHMI	MBA I Year	P	P
37	189L1E0037	K SANTHI	MBA I Year	P	P
38	189L1E0038	KANALA MALLIKARJUNA GOUD	MBA I Year	P	P
39	189L1E0039	KARUKULLA SATEESHREDDY	MBA I Year	P	P
40	189L1E0040	KOMMARAGUNTTA THULASI	MBA I Year	P	P
41	189L1E0041	KONDREDDY SURESH REDDY	MBA I Year	P	P
42	189L1E0042	KOTHA BHARGAVI	MBA I Year	P	P
43	189L1E0043	KOVURI TEJASWI	MBA I Year	A	P
44	189L1E0044	KURAKULA KUMARA SWAMY *	MBA I Year	P	P
45	189L1E0045	M LOKESH *	MBA I Year	A	P
46	189L1E0046	MADUGU RIVAN KUMAR	MBA I Year	P	P
47	189L1E0047	MANGAMMAGARI VINOD KUMAR	MBA I Year	P	P
48	189L1E0048	MARAGANI PRASANTHI	MBA I Year	P	P
49	189L1E0049	MEDAM KRISHNAREDDY	MBA I Year	P	P
50	189L1E0050	MULABAGAL NAGENDRA BABU	MBA I Year	P	P
51	189L1E0051	MUNAGA HEMANTH KUMAR *	MBA I Year	P	P
52	189L1E0052	MUTTAMADUGU LAKSHMI	MBA I Year	P	P
53	189L1E0053	N RAGHUNATH	MBA I Year	P	P
54	189L1E0054	NAGAMALLA REDDYGARI BHASKAR REDDY	MBA I Year	P	P
55	189L1E0055	NAGIREDDYGARI VYSHNAVI	MBA I Year	P	P
56	189L1E0056	NALLANDULA GNANAPRASANNA *	MBA I Year	A	P
57	189L1E0057	P HARI	MBA I Year	P	P
58	189L1E0058	PALAKURU VENKATESH	MBA I Year	P	P
59	189L1E0059	PALAPARTHI NAGENDRA BABU	MBA I Year	P	P
60	189L1E0060	PALLEMPALLI MAHENDRA REDDY *	MBA I Year	P	P
61	189L1E0061	PANDARI RAMU *	MBA I Year	P	P
62	189L1E0062	PANDIKUNTA USHA	MBA I Year	P	P
63	189L1E0063	POKANATI SATHISH KUMAR	MBA I Year	P	P
64	189L1E0064	POLEPALLI RAJESH	MBA I Year	P	P
65	189L1E0065	POLI PRUDHVI	MBA I Year	P	P
66	189L1E0066	POOJARI DHANASEKHAR	MBA I Year	P	P
67	189L1E0067	RACHINENI NARESH	MBA I Year	A	P
68	189L1E0068	RAMAKKA GARI SONIA	MBA I Year	P	A
69	189L1E0069	RASURI NAGALAKSHMI	MBA I Year	P	P
70	189L1E0070	SALVA MAHESH *	MBA I Year	P	P
71	189L1E0071	SANAM RAMALINGESWARA REDDY *	MBA I Year	P	P
72	189L1E0072	SANGAPATNAM VEERANJANEYULU	MBA I Year	P	P
73	189L1E0073	SHAIK MUSHA	MBA I Year	P	P
74	189L1E0074	TEPALLE GANESH	MBA I Year	P	P
75	189L1E0075	THERLA SREE HARI	MBA I Year	P	P
76	189L1E0076	V R SAILAJA *	MBA I Year	P	P
77	189L1E0077	VADAKAPU VENKATASUBBAIAH	MBA I Year	P	A
78	189L1E0078	VEMULA SURESH KUMAR REDDY	MBA I Year	P	P
79	189L1E0079	VEMURI REDDIDILEEP	MBA I Year	P	P
80	189L1E0080	YADALA HAREESH	MBA I Year	P	P



SIDDARTHA EDUCATIONAL ACADEMY GROUP OF INSTITUTIONS
(An Integrated Campus for Engineering & MBA)
Approved by AICTE, New Delhi & Affiliated to JNTUA, Ananthapuramu, AP.
Near C. Gollapalli, Tirupati – 517 505, Andhra Pradesh

81	189L1E0081	ADEM ASHA	MBA I Year	P	P
82	189L1E0082	P. PRABHAVATHI	MBA I Year	P	P
83	189L1E0083	M. SRAVANI	MBA I Year	A	P
84	189L1E0084	G.PARAMESWAR NAIDU	MBA I Year	A	A

Co-ordinator

HOD
Dept. of MBA
Signature of the HOD
Siddhartha Educational Academy
Group of Institutions
TIRUPATI - 517 505

PRINCIPAL
Siddhartha Educational Academy
Group of Institutions
Near C.Gollapalli, Tirupati-517 505



SIDDARTHA EDUCATIONAL ACADEMY GROUP OF INSTITUTIONS

(An Integrated Campus for Engineering & MBA)

**Approved by AICTE, New Delhi & Affiliated to JNTUA, Ananthapuramu, AP.
Near C. Gollapalli, Tirupati – 517 505, Andhra Pradesh**

Department of MBA

**A Summary Report of
Workshop on
Soft skills & Development**

A Workshop on “Soft skills and Development” was conducted by department of MBA during **11-03-2019 to 12-03-2019**. A total of 84 students of MBA department attended the Workshop.

The Program started at 10:00am with prayer song by Mrs.M.B.Jyothi, Assistant Professor, Department of MBA, followed by welcome address by Ms.K.Hima Bindu, Assistant Professor, Department of MBA to resource person and participants, Mr.P.Bayya Reddy, Head of MBA department introduced by resource person.



The session is handover to the guest speaker, Dr.Mahesh Pavan, Soft skills Trainer & he spoke on the promience of Softskills, The entire program was an interactive session and the speaker answered many queries raised by the students.

The session ended with the vote of thanks proposed by, Mrs.A.Usha Rani, Assistant Professor, Department of MBA.

The entire program was coordinated successfully with the support of the principal and faculty.

Finally we closed this seminar with National Anthem.

[Signature]
Dept. of MBA
Siddhartha Educational Academy
Group of Institutions
TIRUPATI - 517 505

[Signature]
PRINCIPAL
Siddhartha Educational Academy
Group of Institutions
Near C.Gollapalli, Tirupati-517 505



SIDDARTHA EDUCATIONAL ACADEMY GROUP OF INSTITUTIONS
(An Integrated Campus for Engineering & MBA)
Approved by AICTE, New Delhi & Affiliated to JNTUA, Ananthapuramu, AP.
Near C. Gollapalli, Tirupati – 517 505, Andhra Pradesh

Request letter

Date :17.07.2018

From

The Head
Department of the CSE
SEAGI, Tirupati

To

The Principal
SEAGI, Tirupati

Respected Sir,

Sub: Request for approval to conduct a Workshop on “**INTRODUCTION OF PYTHON**” – reg

We are planning to conduct a workshop on “**INTRODUCTION OF PYTHON**” for the II, III & IV year students to enhance their knowledge for the Python programming. We request you to give permission to conduct the workshop on 19.07.2018 & 20.07.2018

Thanking you

Yours sincerely

HOD
Dept. of CSE
Siddhartha Educational Academy
Group of Institutions
TIRUPATI - 517 505



SIDDARTHA EDUCATIONAL ACADEMY GROUP OF INSTITUTIONS

(An Integrated Campus for Engineering & MBA)

Approved by AICTE, New Delhi & Affiliated to JNTUA, Ananthapuramu, AP.

Near C. Gollapalli, Tirupati – 517 505, Andhra Pradesh

File No: SEAGI/CSE/Workshop/2018-2019

Circular

Date: 17.07.2018

The Department of Computer Science and Engineering is organizing for a workshop “**INTRODUCTION OF PYTHON**” for the students of All B.Tech CSE. All the students of II,III & IVYear B.Tech CSE are hereby informed to register for workshop on or before 18.07.2018. The coordinator for the workshop is Mr N. Anand Reddy, Asst. Professor Department of CSE.

Venue: CSE seminar Hall

Date: 19th & 20.07.2018

Timings: 9:30 am onwards

HoD / CSE

HOD
Dept. of CSE
Siddhartha Educational Academy
Group of Institutions
TIRUPATI - 517 505

Principal
Siddhartha Educational Academy
Group of Institutions
Near C.Gollapalli, Tirupati-517 505



SIDDARTHA EDUCATIONAL ACADEMY GROUP OF INSTITUTIONS
(An Integrated Campus for Engineering & MBA)
Approved by AICTE, New Delhi & Affiliated to JNTUA, Ananthapuramu, AP.
Near C. Gollapalli, Tirupati – 517 505, Andhra Pradesh

Workshop on

INTRODUCTION OF PYTHON

Resource Person
Mr C. Ramesh Reddy
Assistant Professor
Department of Computer Science and Engineering
SREC , Tirupati

Date : 19th and 20th July 2018
Venue: CSE- Seminar Hall

Organized by
Department of computer Science and Engineering



SIDDARTHA EDUCATIONAL ACADEMY GROUP OF INSTITUTIONS
(An Integrated Campus for Engineering & MBA)
Approved by AICTE, New Delhi & Affiliated to JNTUA, Ananthapuramu, AP.
Near C. Gollapalli, Tirupati – 517 505, Andhra Pradesh

Computer Science and Engineering Department

Summary Report for Two Days Workshop

The Department of Computer Science and Engineering, organized a workshop on INTRODUCTION OF PYTHON for students of CSE, on 19-07-2018 to 20-07-2018. Totally 74 students are participate this workshop. The Workshop first day deal with the basic ideas of Python and how to code in the Anaconda navigator. Hands-on practical session about python introduction variable using variables, understanding data types using operators, writing statements and comments using conditional statements, if(), else if() and else if condition statement, creating an array, modifying array elements and processing arrays with loops.

The second day was continued with Python & MySQL. Hands-on practical session in creating database connectivity using Python & MySQL queries like MySQL CONNECTIVITY, INSERT, and UPDATE, SELECT, DELETE and VIEW. They also gave information about Data analytics and Visualization like graphical representation. Later, Individuals projects based on Python & MySQL were discussed. The two-day workshop designed for the beginners to understand the Python Programming & its use with MySQL.

HoD / CSE

Dept. of CSE
Siddhartha Educational Academy
Group of Institutions
TIRUPATI - 517 505



SIDDARTHA EDUCATIONAL ACADEMY GROUP OF INSTITUTIONS

(An Integrated Campus for Engineering & MBA)

Approved by AICTE, New Delhi & Affiliated to JNTUA, Ananthapur

Near C. Gollapalli, Tirupati – 517 505, Andhra Pradesh

Computer Science and Engineering Department

Workshop on
Introduction to Python



Resource person Presentation



SIDDARTHA EDUCATIONAL ACADEMY GROUP OF INSTITUTIONS

(An Integrated Campus for Engineering & MBA)

Approved by AICTE, New Delhi & Affiliated to JNTUA, Ananthapur

Near C. Gollapalli, Tirupati – 517 505, Andhra Pradesh

Computer Science and Engineering Department

Workshop on
Introduction to Python
Attendance Sheet

S.No	Roll No.	Name of the Students	Class & Branch	Attendance
1.	169L1A0508	BITTA DILLI KUMAR	IV CSE	Dilli
2.	169L1A0510	BOVILLA LAKSHMI BHARATHI	IV CSE	Bharathi
3.	169L1A0511	C BHAVYA	IV CSE	Bhavya
4.	169L1A0512	C V SHRAVAN REDDY	IV CSE	Shravan
5.	169L1A0513	CHALLA NAVYA SREE	IV CSE	A
6.	169L1A0514	CHAMARTHI CHANDRALEKHA	IV CSE	C. chandra Lekha
7.	169L1A0515	CHINNABAYANNAGARI KEERTHI REDDY	IV CSE	Keerthi Reddy.
8.	169L1A0516	CHINNAMUTHU BALAJI REDDY	IV CSE	C. Balaji
9.	169L1A0518	CHUKKA SWAPNA	IV CSE	Swapna
10.	169L1A0519	DASARA RAJU NAGA LAKSHMI	IV CSE	Lakshmi

11.	169L1A0520	DEVAPATLA PADMAJA	IV CSE	Padma
12.	169L1A0508	BITTA DILLI KUMAR	IV CSE	Dilli
13.	169L1A0532	KALIKAPURAM KALYANI	IV CSE	K. Kalyani
14.	169L1A0533	KAMASANI SWAPNA	IV CSE	Swapna
15.	169L1A0540	MAKATI PREETHI	IV CSE	Preethi
16.	169L1A0541	MANDADI MUNI SUNANDA KUMARI	IV CSE	A
17.	169L1A0542	MANNURU PRAVALLIKA	IV CSE	M. Pravallika
18.	169L1A0545	MITTAPALLI KINNERA	IV CSE	Kinnera
19.	169L1A0553	NALEPIREDDY SAI KRISHNA REDDY	IV CSE	Sai Krishna P
20.	169L1A0555	NARALA HEMA LATHA	IV CSE	Hema Latha
21.	169L1A0557	NARASAPURAM CHANDUKUMAR	IV CSE	Chandu Kumar
22.	169L1A0560	P RACHANA REDDY	IV CSE	Rachana Reddy
23.	169L1A0568	PULIGUNDLA MAHESH	IV CSE	Mahesh
24.	169L1A0570	PUTTURU LOKESH REDDY	IV CSE	A
25.	169L1A0571	R PURUSHOTHAM	IV CSE	Purushotham
26.	169L1A0580	SIRIGILI GAMYA	IV CSE	Gamyas
27.	169L1A0581	TAMMISSETTY MANASA	IV CSE	T. Manasa
28.	169L1A0582	TERAVA SAISOWMYA	IV CSE	Sai Sowmya

29.	169L1A0550	MUDE AKSHITHA	IV CSE	Akshitha
30.	169L1A0551	MUDIGONDA PRANATHI	IV CSE	A
31.	169L1A0552	NAGALAPURAM SRAVYA	IV CSE	Sravya
32.	169L1A0553	NALEPIREDDY SAI KRISHNA REDDY	IV CSE	Sai Krishna
33.	169L1A0555	NARALA HEMA LATHA	IV CSE	Hema Latha
34.	169L1A0559	P PADMA PRIYA	IV CSE	P. PADMA PRIYA
35.	169L1A0560	P RACHANA REDDY	IV CSE	A
36.	169L1A0561	P RAJESWARI	IV CSE	Rajeswari
37.	169L1A0562	PALLAM PRUDHVIKUMAR	IV CSE	Prudhvikumar
38.	169L1A0563	PASUPULETI SAI KUMAR	IV CSE	Sai Kumar
39.	169L1A0564	PATTAN PEER KHAN	IV CSE	Peer Khan
40.	169L1A0568	PULIGUNDLA MAHESH	IV CSE	Mahesh



HOD

Dept. of CSE

Siddhartha Educational Academy

Group of Institutions

TIRUPATI - 517 505



**SIDDARTHA EDUCATIONAL ACADEMY GROUP OF INSTITUTIONS (An
Integrated Campus for Engineering & MBA) Approved by AICTE, New Delhi &
Affiliated to JNTUA, Ananthapuramu, AP. Near C. Gollapalli, Tirupati – 517 505,
Andhra Pradesh**

From

P. Sai Prasad

HOD, Dept of ECE

SEAGI, Tirupati.

To

The Principal,

SEAGI,

Tirupati.

Respected sir,

Sub: Requesting permission for conducting one day workshop– reg.

We are planning to conduct one day workshop on “**ADAPTIVE SIGNAL PROCESSING**” for students to enhance their knowledge in recent trends. I request you to grant permission to conduct workshop on 23-07-2018.

Thanking you sir,

Resource person

Dr. C. Subhas,
PROFESSOR , Dept. Of ECE.
SVNE,A. Rangampet,
Chittoor. A.P.

Yours sincerely,

(P. Sai Prasad)

Dept. of ECE

Siddhartha Educational Academy
Group of Institutions
TIRUPATI, AP. 517 505



SIDDARTHA EDUCATIONAL ACADEMY GROUP OF INSTITUTIONS (An Integrated Campus for Engineering & MBA) Approved by AICTE, New Delhi & Affiliated to JNTUA, Ananthapuramu, AP. Near C. Gollapalli, Tirupati – 517 505, Andhra Pradesh

Circular

Date: 17.07.2018.

All the staff and students are hereby informed that Electronics and Communication engineering department is organized a one day workshop on “**ADAPTIVE SIGNAL PROCESSING**” by Dr. C. Subhas, Professor , Dept. Of ECE. SVNE, A. Rangampet, Chittoor. A.P. on 23.07.2018. So, all the IV year students are instructed to attend the program without fail.

Venue: ECE seminar Hall

Timings: 10 am onwards

HoD./ECE
Dept. of ECE
Siddhartha Educational Academy
Group of Institutions
TIRUPATI - 517 505

Principal
PRINCIPAL
Siddhartha Educational Academy
Group of Institutions
Near C.Gollapalli, Tirupati-517 505



SIDDARTHA EDUCATIONAL ACADEMY GROUP OF INSTITUTIONS (An Integrated Campus for Engineering & MBA) Approved by AICTE, New Delhi & Affiliated to JNTUA, Ananthapuramu, AP. Near C. Gollapalli, Tirupati – 517 505, Andhra Pradesh

WORKSHOP

ON

ADAPTIVE SIGNAL PROCESSING

BY

**Dr. C. Subhas,
Professor , Dept. Of ECE.
SVNE, A. Rangampet,
Chittoor. A.P.**

Organized By

Department

Of

ELECTRONICS AND COMMUNICATION ENGINEERING

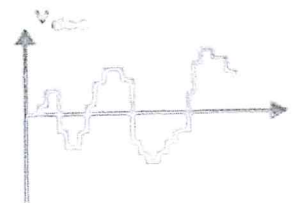
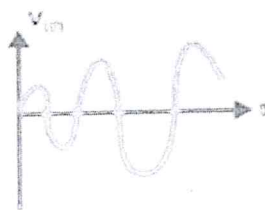

VENUE

**SEAT E-Class Room
Date: 23-07-2018
From 10.00 A.M To 04.00 P.M**

Co-ordinator

**K Bhaskar, Assistant professor,
Dept of ECE-SEAT,
Tirupati.**

**HOD
Dept. of ECE
Siddhartha Educational Academy
Group of Institutions
Tirupati-517 505**

**PRINCIPAL
Siddhartha Educational Academy
Group of Institutions
Near C.Gollapalli, Tirupati-517 505**



SIDDARTHA EDUCATIONAL ACADEMY GROUP OF INSTITUTIONS (An Integrated Campus for Engineering & MBA) Approved by AICTE, New Delhi & Affiliated to JNTUA, Ananthapuramu, AP. Near C. Gollapalli, Tirupati – 517 505, Andhra Pradesh

Resource person presentation



A. Sanyal
HOD
Dept. of ECE
Siddhartha Educational Academy
Group of Institutions
TIRUPATI - AP

or
PRINCIPAL
Siddhartha Educational Academy
Group of Institutions
Near C.Gollapalli, Tirupati-517 505



SIDDARTHA EDUCATIONAL ACADEMY GROUP OF INSTITUTIONS (An Integrated Campus for Engineering & MBA) Approved by AICTE, New Delhi & Affiliated to JNTUA, Ananthapuramu, AP. Near C. Gollapalli, Tirupati – 517 505, Andhra Pradesh

ELECTRONICS AND COMMUNICATION ENGINEERING DEPARTMENT

Attendance

Sl. No.	Roll No.	Name of the Candidate	Signature
1	159L1A0402	ALLADI SRAVANI	✓
2	159L1A0403	ALLAMPATI DIVYA	✓
3	159L1A0404	AMASA GURUKALYAN	✓
4	159L1A0405	AMBATI LAKSHMI	✓
5	159L1A0406	AMBATI MOUNIKA	✓
6	159L1A0407	AMBATI RADHA	✓
7	159L1A0408	BODIBANDA BALAJI	✓
8	159L1A0409	BOLLINENI VENKATA RAMANA	✓
9	159L1A0410	DINDIKURTI VENKATA SAI TEJA	✓
10	159L1A0411	ERIKI SAISREE	✓
11	159L1A0412	GAJJALA BHANUPRASAD	✓
12	159L1A0413	GANACHARI CHANDRANA	✓
13	159L1A0414	GANGISETTI BASETTI SAI SUMANTH	✓
14	159L1A0416	GUDISE LAKSHMIPRASANNA	✓
15	159L1A0417	GUNDRE SRAVAN KUMAR REDDY	✓
16	159L1A0418	GUTTAPALEM MAHITHA	✓
17	159L1A0420	KAKARLA PAVAN	✓
18	159L1A0421	KALAVAKOLLI MAHESH	✓
19	159L1A0422	KATINENI ASHOKA NAIDU	✓
20	159L1A0423	KAYAM YAMINI	✓
21	159L1A0424	KOLA SUBRAMANYAM	✓
22	159L1A0425	KOLA VAMSEE KRISHNA	✓
23	159L1A0426	KOMMA SIVA PRIYANKA	✓
24	159L1A0427	KOPPALA RUCHITA RAM	✓
25	159L1A0429	KOTHAMEKALA SRIKANTH REDDY	✓
26	159L1A0430	MADDERI HARITHA	✓

P. Gop
Dept. of ECE
Siddhartha Educational Academy
Group of Institutions
TIRUPATI - 517 50*

ar
PRINCIPAL
Siddhartha Educational Academy
Group of Institutions
Near C.Gollapalli, Tirupati-517 505



SIDDARTHA EDUCATIONAL ACADEMY GROUP OF INSTITUTIONS (An Integrated Campus for Engineering & MBA) Approved by AICTE, New Delhi & Affiliated to JNTUA, Ananthapuramu, AP. Near C. Gollapalli, Tirupati – 517 505, Andhra Pradesh

27	159L1A0431	MADDINA PHALGUNA	✓
28	159L1A0433	MANABOTHULA SASIKUMAR	✓
29	159L1A0434	MANCHURU SRAVANI	✓
30	159L1A0435	MASI REDDY DEDEEPPYA	✓
31	159L1A0436	METHIKAYALA NARESH KUMAR	✓
32	159L1A0437	MURABOINA SUDHAKAR	✓
33	159L1A0438	MUSALI SUSHMITHA	✓
34	159L1A0439	NAGIREDDYGARI APARNA	✓
35	159L1A0440	PAGADALA SUBRAMANYAM	✓
36	159L1A0441	PALYAM KAVYA	✓
37	159L1A0442	PANAKANAPALLE VAMSIVARDHAN REDDY	✓
38	159L1A0443	PAPINENI NEELIMA	✓
39	159L1A0444	POLU MANASA	✓
40	159L1A0445	POTTELI LAVANYA	✓
41	159L1A0446	S LAHARI	✓
42	159L1A0447	S YOGESH	✓
43	159L1A0448	SANGARAJU VENKATESWARA RAJU	✓
44	159L1A0449	SINGAMALA SIVANI	✓
45	159L1A0450	THANGELI MANOJ KUMAR REDDY	✓
46	159L1A0451	TIRUMALA HARICHANDANA	✓
47	159L1A0452	VEERABALLI SIVA PRASAD	✓
48	159L1A0453	VIDADALA ANUSHA	✓
49	159L1A0454	YAGANTI NARASIMHA REDDY	✓
50	169L5A0402	CHAPPIDI ANITHA	✓
51	169L5A0403	DHULI CHAITHANYA	✓
52	169L5A0404	DULLA MADHU PRIYA	✓
53	169L5A0405	J PAVANI	✓
54	169L5A0406	JWALAPURAM CHANDRA KALA	✓
55	169L5A0407	K UMA DEVI	✓
56	169L5A0408	KANIKE VANI	✓
57	169L5A0409	KAPA REVATHI	✓

Dept. of ECE
Siddhartha Educational Academy
Group of Institutions
TIRUPATI - 517 505



PRINCIPAL
Siddhartha Educational Academy
Group of Institutions
Near C.Gollapalli, Tirupati-517 505



SIDDARTHA EDUCATIONAL ACADEMY GROUP OF INSTITUTIONS (An Integrated Campus for Engineering & MBA) Approved by AICTE, New Delhi & Affiliated to JNTUA, Ananthapuramu, AP. Near C. Gollapalli, Tirupati – 517 505, Andhra Pradesh

58	169L5A0410	KENCHUGUNDU MADHULATHA	✓
59	169L5A0412	MARIKINTI MANI KANTA	✓
60	169L5A0413	METI SUPRIYA	✓
61	169L5A0414	PATHIPATI SASHANK	✓
62	149L1A0405	B V K MAHESH KUMAR	✓
63	149L1A0406	B KRISHNA HARSHA	✓
64	149L1A0417	GUDETI RANJITH KUAMR	✓
65	149L1A0425	KAMBOTHU CHAKRESH	✓
66	149L1A0438	M NARAYANA RAO	✓
67	139L1A0419	C REDDY KISHORE REDDY	✓
68	139L1A0457	N SAI KUMAR	✓
69	149L1A0468	V SUDHARSHAN REDDY	✓

HOD ECE
Dept. of ECE
Siddhartha Educational Academy
Group of Institutions
TIRUPATI - 517 505

PRINCIPAL
Siddhartha Educational Academy
Group of Institutions
Near C.Gollapalli, Tirupati-517 505



Date: 24-07-2018

ELECTRONICS AND COMMUNICATION ENGINEERING DEPARTMENT

Summary Report for Two Days Workshop

The one day Workshop on “**ADAPTIVE SIGNAL PROCESSING**” was organized by Electronics and Communication Engineering Department with associate with SVNE, Chittoor. The event was schedule on 23rd JULY 2018. A total of 70 participants comprising principal, Head of the department, faculty members and students attend the program.

The program started at 10:00am with prayer song by Ms. SANGA JAAHNAVI and team IV ECE students followed by welcome address by Mr.D Vijayakumar Reddy Assistant Professor, Department of ECE to resource person and participants and Mr. P Sai Prasad, Head, Department of ECE introduced resource person.

The Day -1 session is handover to the Guest Speaker Mr Dr. C. Subhas, Professor , Dept. Of ECE. SVNE, A. Rangampet, Chittoor. A.P. He explains about **adaptive signal processing** . He explains that Adaptive filter is essentially a digital filter with self Adjusting characteristics. It adapts, automatically, to changes in its input signals. Strictly speaking adaptive filters are nonlinear, as they involve hard outputs instead of soft outputs

The next session begin with Filter Structures. He told that Conventional adaptive filters are linear. There are two types of filters. The structures of the filter are Finite impulse response (FIR) (Transversal -- Lattice -- Systolic array) and Infinite impulse response (IIR). The session is ended at 3:50 pm

In the interactive session, the queries and clarification of the participants were addressed by the resource person. The participant has been given the feedback about the -2 sessions.

The session is ended with the vote of thanks by Mrs. N. Pavithra Assistant Professor, Department of ECE.

Finally we closed this workshop program with National Anthem.

More than 70 participants were benefited from the workshop.

HOD / ECE
Dept. of ECE
Siddhartha Educational Academy
Group of Institutions
TIRUPATI - 517 505

PRINCIPAL
Siddhartha Educational Academy
Group of Institutions
Near C.Gollapalli, Tirupati-517 505